



eFOLDi®



eFOLDi User Manual

Model: Lite

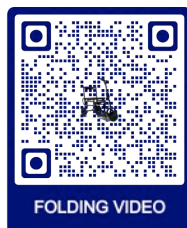

SunTech UK Ltd

Purchased from:

Date of purchase:

Serial number:

Please see image showing the location of the serial number.



Contents

1	Welcome	2
2	Terms, conditions and disclaimers	3
3	Product overview	6
4	Components	7
5	Safety guidance	8
6	(Un)/Folding instructions	13
7	Drive your scooter	18
8	Battery and Charging	21
9	Checks and maintenance	24
10	Technical specification/EMC declaration	25
11	Appendix	31

Welcome

Thank you for choosing an eFOLDi product as your mobility solution.

I'm Sumi Wang, the founder of SunTech UK and would like to welcome you to the eFOLDi family of users.

SunTech UK manufactures a range of assistive technologies to help you get the most from life. Our mission is to give our customers freedom, friendship and fun with a range of easy to use, convenient and market leading mobility solutions.

Your eFOLDi has been manufactured to the highest standards and quality checked by our own pre-sales technicians before delivery, to provide you with a product that will give many years of freedom and fun with reliable service.

Please take some time to read the user manual and the supplied documents before using your eFOLDi for the first time, this will help you understand the product and help you obtain maximum enjoyment and safety from your new eFOLDi product(s). You will quickly become familiar with the features of your eFOLDi with a little practice.

SunTech UK prides itself on its high-quality products and customer support so please remember to register your product(s) at: <https://efoldi.com/register-warranty>

These will help us to assist you in the event of any difficulties you may experience in the future. I am sure you will find your eFOLDi to be a reliable friend and companion and I thank you for your custom and your trust in our products.

Yours,



Sumi Wang

Terms, conditions and disclaimers

The terms 'us', 'we', 'our', 'SunTech UK' and 'SunTech UK Ltd' mean SunTech UK Limited, which is a UK registered company, limited by guarantee, registered with Companies House, number 06906908. The terms 'website' means the website found online at www.efoldi.com. The terms 'you', 'your', 'user' and 'rider', mean the person using the eFOLDi not withstanding any person(s) handling the eFOLDi on behalf of the user, if different to the user, including general handling, maintenance, repairs and so on.

Purchaser's agreement

By accepting delivery of this eFOLDi, you undertake to not change, alter or modify this eFOLDi and/or any parts supplied with it or subsequently for it, and/or render inoperable or unsafe, any guards, shields or other safety features of this product; fail, refuse or neglect to install any retrofit kits from time to time, as may be provided by SunTech UK Ltd to enhance and/or preserve the safe use of this product . You also agree to accept and abide, by/with the terms and conditions contained herein and as may be revised from time to time and updated on our website, being immediately applicable. By using the eFOLDi and/or accessories and/or components supplied with/or for the eFOLDi, the user acknowledges having read and understood the use(s) and limitations of the product(s) without exceptions. This shall not act as a waiver of any implied warranties, which customer retains, as provided by law.

Warranties will be void and SunTech UK Ltd will accept no responsibility whatsoever or howsoever, in instances of misuse and/or abuse of the products, in part or in full, by the user and/or any unauthorised persons, which may include (but not to be limited to); the user(s) failing to comply with all legal requirements and guidelines, wherever and/or however it is used or intended to be used, lack of or inappropriate maintenance, maintenance (apart from the routine maintenance as described in this manual by the user) by anyone not approved to do so, unapproved repairs, unauthorised disassembly of the vehicle and/or components includ-

ing (but not limited to) battery pack(s) and controllers, unapproved modifications or alterations, failure to ensure correct folding and unfolding procedures are followed precisely and in full, damage or injury howsoever caused, failure to apply all reasonable and appropriate safety precautions at all times, improper use of the vehicle and/or parts and/or accessories being used by more than one person at any times, use in any competitive sport, racing, stunts, jumping or other similar activity.

Our liability and the liability of our suppliers, to you/or any third parties in any circumstances is limited to the user's cost of qualifying products purchased. Qualifying products as acceptable for the return, as outlined in the return policy, as stated on the website online at: www.efoldi.com/return-policy.

Information in this user manual is subject to change without prior notice. For the latest updates and information, please go to our website online at: www.efoldi.com.



The scooter should NOT be used by:

People who are unable to:

- Fold or unfold it using both hands*;
- Transfer themselves onto the seat* and remain in a seated upright position at all times, without assistance while the vehicle is in motion;
- Place and keep your feet on the Lite;
- Operate all controls fully and as intended;
- Steer competently and appropriately at all times and in all conditions;
- Maintain appropriate awareness of all relevant circumstances for each journey and take appropriate action as may be required to avoid injury;
- Lift it in whole or in part as may be required dependent upon user's needs*.

*Unless accompanied by a person sufficiently able and competent to carry out that task.

Product compliance:

Safety:	EN12184 and ISO 7176-15
EMC:	ISO7176-21
Risk management:	ISO14971
The European Medical Devices:	Directive of 2017/745/EU

Shipping and delivery:

By checking against your sales order or invoice, make sure your delivery is complete, as some components may be individually packaged. If you do not receive a complete delivery, please contact us immediately. Where damage has occurred during transport, either to the packaging or the content, please contact the delivery company responsible.

Product overview

Indications for use:

eFOLDi Lite is a motor driven, indoor and outdoor transportation vehicle with the intended use to provide mobility to a disabled person or a person with limited mobility in a seated position. eFOLDi Lite is one of the worlds lightest, most compact, folding mobility scooters. Weighing only 17kg with battery and no larger than a small suitcase when folded. Amazingly easy to setup and fold - fully airline compliant, eFOLDi Lite is the perfect super lightweight travel companion.



(a) Suitcase mode



(b) Trolley Mode



(c) Scooter Mode

Model: Lite

Intended use / purpose of the device:

The device is intended to provide mobility to a disabled person or a person with limited mobility in a seated position.

Expected device lifespan:

Due to the inert nature of the device component, SunTech UK Ltd. does not have an expiration date to the device. Check the scooter regularly as you use it and make sure the battery is charged before use.

Components

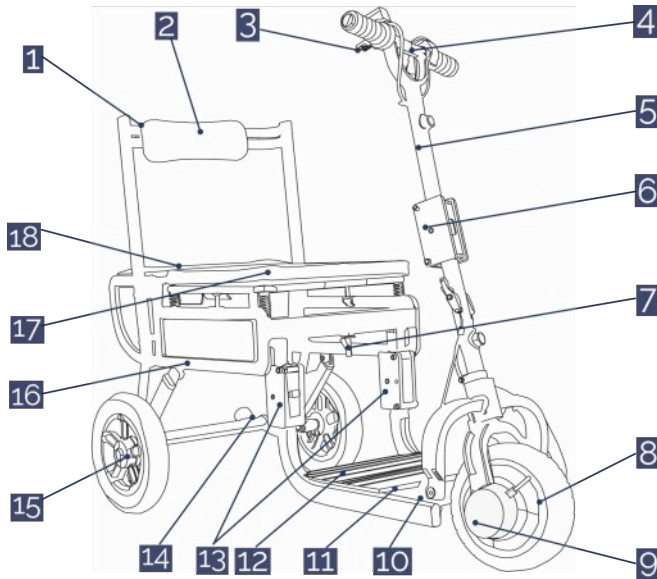

1	Backrest frame	2	Backrest pad
3	Accelerator/gradual brake lever	4	Handle bar
5	Steering column	6	Steering stem folding lock
7	Steering stem/frame latch	8	Front motor
9	Front brake lock lever *	10	Stainless steel hinges
11	Footrest and battery compartment	12	Controller compartment
13	Hinge to fold footrest	14	2 inch suitcase wheels
15	10 inch Rear wheels	16	Main frame
17	Main seat pad	18	Rear seat pad

*The brake is on the other side of wheel, the above image is for illustration purpose only.

Table 1: Model Lite Components

Safety guidance

Do not operate your scooter for the first time without completely reading and understanding this user manual.



Safety Instruction

- Never operate the scooter while you are under the influence of alcohol;
- Never use mobile phones or radio transmitters such as walkie-talkies while driving your scooter;
- Make sure that there are no obstacles behind you while reversing your scooter;
- Do not attempt to climb kerbs greater than 4cm shown in the specification;
- Do not ride over rough, cobbled, muddy or loose gravel surfaces. Your eFOLDi is designed for smooth and firm footpaths and pedestrian areas only;
- Do not remove your hands and legs from the scooter when driving;
- Do not ride your scooter during snow in order to avoid accidents;
- Do not allow unsupervised children to play near this equipment while the batteries are charging;
- Do not ride your scooter in traffic;
- Do not drive or sit on the scooter when in freewheel mode;
- Do not make a sharp turn or a sudden stop while riding your scooter;
- Never try to use your scooter beyond its limitations as described in this manual;
- Always switch off the scooter and charger before doing any work or using any tools on the scooter.



Warning

- It is the user's responsibility to read the manual and supplied documents before using the eFOLDi and to follow all of the recommendations contained within, to fully comply with all local laws of their countries and localities and to use the eFOLDi with due diligence and regard to other road users and pedestrians;
- Do not operate the scooter on the road. Obey all local pedestrian traffic rules and use the pavement. Be aware that it may be difficult for traffic to

- see you when you are seated on the scooter. Wait until your path is clear of traffic, and then proceed with extreme caution;
- The eFOLDi is simple to use, but its folding mechanism can cause significant injury if used inappropriately and handled without due care and diligence. To avoid any risk of injury ensure hands, fingers, jewellery, clothing and other objects are not allowed to interfere with the folding mechanism or moving parts of the eFOLDi and study the manual carefully before you start operating your eFOLDi;
 - It is advised that the user familiarise themselves with the folding and unfolding procedure before venturing outside. The user should also ensure that they familiarise themselves with the controls and handling of the scooter in a safe area away from obstacles and other pedestrians or road users;
 - eFOLDi users are recommended to wear appropriate clothing when using a mobility scooter which should include an approved helmet, sturdy shoes or boots, appropriate gloves and high visibility protective clothing as a safety precaution;
 - Fully charge the battery(ies) before first use and follow the guidelines in this manual and on label on base of battery for prolonging the life of your battery;
 - Your eFOLDi Lite should only be stood on its main rear wheels and suitcase wheels when it is on level and stable ground;
 - To prevent injury to yourself or others, always ensure that the power is switched off when getting on or off of the scooter;
 - Always check that the drive wheels are engaged (drive mode) before driving. Do not switch off the power when the scooter is still moving forward. This will bring the scooter to an extremely abrupt stop.
 - Do not use this product or any available optional equipment without first completely reading and understanding these instructions. If you are unable to understand the warnings, cautions or instructions, contact your reseller before attempting to use this equipment, otherwise injury or damage may occur;
 - There are certain situations, including some medical conditions, where the scooter user will need to practice operating the scooter in the presence of a trained attendant. A trained attendant can be defined as a family member or care professional especially trained in assisting a scooter user in various daily living activities;
 - Please do not sit on your scooter while it is in a moving vehicle such as a car, bus or train;
 - Keep your hands away from the wheels (tyres) while driving scooters. Be aware that loose fitting clothing can become caught in the drive wheels;
 - Do not climb a gradient at an angle. Always drive straight up a gradient, as this greatly reduces the risk of tipping or a fall. Do not climb a gradient steeper than 6°;

- Always reduce your speed and maintain a stable centre of gravity when cornering sharply. Do not corner sharply when driving scooters at higher speeds;
- Always switch off the scooter and charger before doing any work or using any tools on the scooter;
- Do not drive or sit on the scooter when in freewheel mode;
- Operating in rain, snow, salt, mist and on icy or slippery surfaces may have an adverse affect on the electrical system;
- Beware the motor may be hot after use. Do not touch or access the motor directly until it has cooled down;
- Never sit on your scooter when it is being used in connection with any type of lift or hoist. Your scooter is not designed with such use in mind and any damage or injury incurred from such use is not the responsibility of SunTech UK Ltd;
- Always ensure the scooter is fully folded out before sitting on the scooter. Do not fold up the scooter until you have fully exited the scooter, and the backrest on the scooter seat is folded down;
- The stopping distance on slopes can be significantly greater than on level ground;
- The scooter surface temperatures can increase when exposed to external sources of heat (e.g. sunlight);
- Your eFOLDi Scooter is NOT a toy and is not recommended for people under the age of 14. Do not allow children to play with or on the scooter. The internal folding mechanism can cause injury to hands;
- Consult your physician if you are taking prescribed medication or if you have any certain physical limitations. Some medications and limitations may impair your ability to operate scooters in a safe manner. Consult with your physician if you are taking any medication that may affect your ability to operate your scooter safely;
- When travelling at speeds greater than a slow walking pace be sure to slow down before turning;
- Any vehicle can be dangerous to its rider/driver and other road users and pedestrians.
- Do NOT for any reason put your hands into the mainframe of the scooter, especially in the last step of the folding process. This is because your hands and fingers can get trapped in the main levers and pivots and serious injuries can be caused;
- Do NOT carry passengers on the eFOLDi scooter. Carrying passengers on the eFOLDi may affect the centre of gravity, resulting in tipping over or falling.

Modification

Your scooter has been designed to be as practical as possible. However, under no circumstances should you modify, add, remove, or disable any part or function of your scooter. Personal injury and damage to the scooter may result.

- Do not modify your eFOLDi scooter in any way not authorised by eFOLDi;
- Do not use accessories if they have not been tested or approved for eFOLDi products;
- Get to know the feel of your eFOLDi scooter and its capabilities. It is highly recommended that you perform a safety check before each use to make sure your eFOLDi operates smoothly and safely.

Weight limitation

- Do not exceed the weight capacity stated in the Specification section. Exceeding the weight capacity voids your warranty. eFOLDi will not be held responsible for injuries or property damage resulting from failure to observe weight limitations;
- Do not carry passengers on scooters. Carrying passengers on your scooter may affect the centre of gravity, resulting in a tip or a fall.

Temperature

- Some of the parts of the scooter are susceptible to change in temperature. The controller can only operate in temperature that ranges between - 25°C 50°C (-13°F to 122°F);
- At extreme low temperatures, the batteries may freeze, and your scooter may not be able to operate. In extreme high temperatures, it may operate at slower speeds due to a safety feature of the controller that prevents damage to the motors and other electrical components.

Safety check

- Check for correct tyre inflation. Maintain but do not exceed the manufacturer recommended tyre pressure rating indicated on the pneumatic tyres;
- Check all electrical connections. Make sure they are secure and not corroded;
- Check and test the brake system;
- Check frequently for any loose fasteners, fixings and other components.



When unfolding/folding your eFOLDi Lite ensure:

- Do not rush when folding or unfolding the eFOLDi scooter;
- The scooter is positioned on a level floor or ground;
- Main switch is switched off;
- All latch pins are properly secured in place, as stated on the instructions and shown on the illustrations.



EMC WARNING STATEMENT

The interference from radio wave sources such as radio stations, TV stations, two way radios or cellular phones can cause the mobility scooter to release its brakes, move by itself, or move in unintended directions. It can also permanently damage the mobility scooter control system.

The intensity of the interfering EM energy can be measured in volts per meter (V/m). Each mobility scooter can resist EMI up to a certain intensity. This is called the "EMI immunity level". The higher the EMI immunity level, the greater the protection from EMI. Currently the eFOLDi scooter has an immunity level of at least 20V/m, which provides useful protection from the common sources of EMI.

The sources of radiated EMI can be broadly classified into three types: 1) Hand-held portable transceivers. (normally with antenna mounted on the device) 2) Medium-range mobile transceivers, such as those used in police cars, fire trucks, ambulances and taxis. (normally with antenna mounted on the vehicle) 3) Long-range transmitters and transceivers, such as commercial broadcast transmitters (radio and TV broadcast antenna towers) and amateur (HAM) radios.

Other types of hand-held devices, such as cordless phones, laptop computers, AM/FM radios, TV sets and small appliances such as electric shavers and hair dryers are usually not likely to cause EMI problems.



MR Safety statement

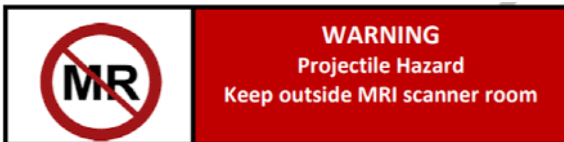

"The eFOLDi Lite scooter is MR Unsafe. The device presents a projectile hazard."

(Un)/Folding instructions

(Un)/Folding steps: Suitcase to Scooter



Please study the instruction and image illumination to familiarise the folding procedures and please only operate one moving part at the same time.

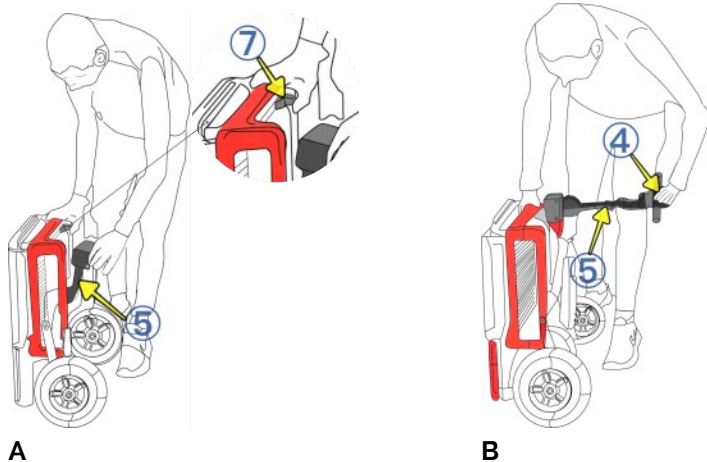

A Position the eFOLDi Lite vertically and release the steering column (5), by pressing the frame latch (7) and release the steering stem completely out while holding the steering column (5).

B Grab the Handle bar (4) from the bottom and raise it 180° degrees vertically, making the Steering column (5) straight.



Do NOT for any reason put your hands into the mainframe of the scooter during each folding process. This is because your hands and fingers can get trapped in the main levers and pivots and serious injuries can be caused.

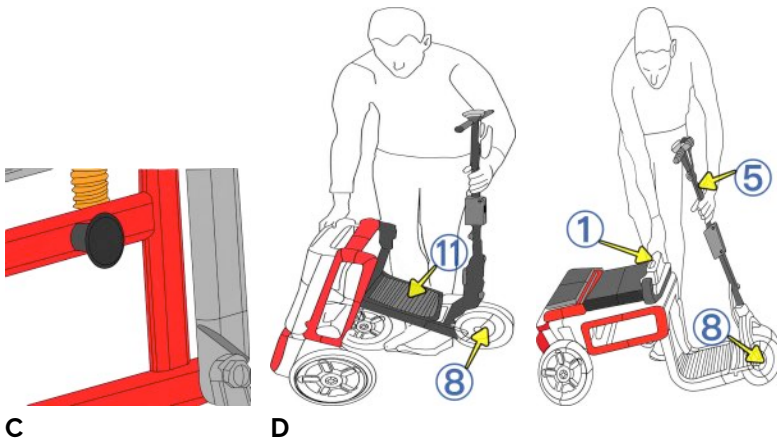

C Pull the knob on the side of the frame, this will release the footrest (11) and the front wheel (8).

D Firmly, hold the front steering column (5) and the top of backrest (1), and then push the steering column (5) forward setting the front wheel (8) on the ground and the footrest (11) on a horizontal position.



The different colours of the eFOLDi scooter and its accessories displayed in this user manual are for clear demonstration purpose only. Black colour of frame is manufacture standard.

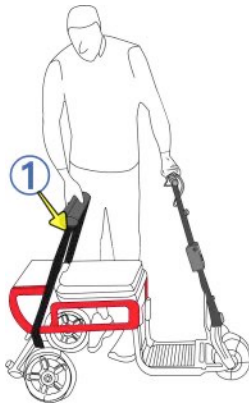

E

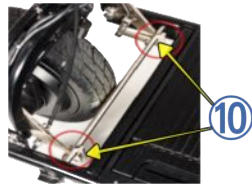

F

E Grab the backrest frame (1) and pull it all the way backwards until it is stable.

F Check the two latches of the hinge (10) at the front of footrest are fully engaged and locked.



Do not rush when folding or unfolding the scooter.

Folding steps: Scooter to Suitcase

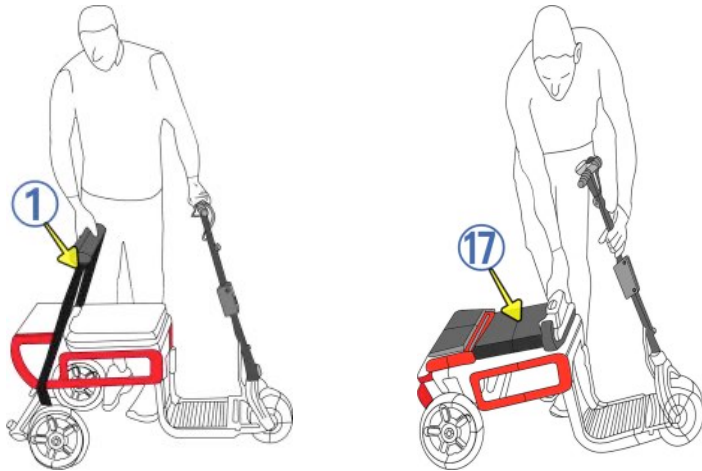

A

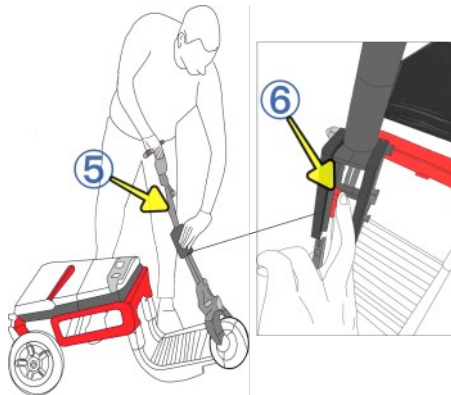

B

A Push and fold the backrest frame (1) on top of the main seat pad (17).

B Push the lock (6) for steering column (5) on the middle rectangular section and fold it in half, in a 180° degrees vertical rotation.



C

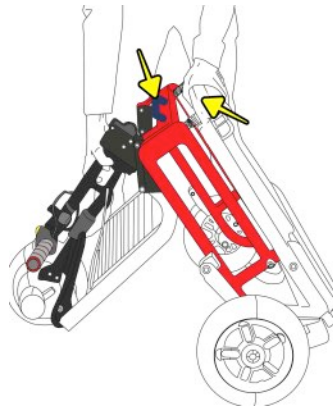

D

C Push the folded steering column (5) towards the footrest (11) while holding the lift handle or the frame using the other hand.

D Finally, with one foot placed behind rear wheel to stop it rolling back, bring it up into a vertical position, grab the handle or back frame and push the steering column into the main frame until it locks in and it clicks.



Do NOT for any reason put your hands into the mainframe of the scooter during each folding process. This is because your hands and fingers can get trapped in the main levers and pivots and serious injuries can be caused.

Drive your scooter



Safety check before use

When driving your eFOLDi, choose a route with good road conditions. The eFOLDi is designed to drive on smooth even surfaces. Unevenly paved roads or paths, potholes and other hazards, will reduce the life of any scooter and your safety.

Do not drive on steep roads or excessively cambered roads. The amount of charge remaining in the battery immediately before commencing any slope upward will be crucial to the climbing ability. Any deviation from level/horizontal surfaces should not exceed a gradient of 1:10 (6 degrees). For any climbing there are many factors that need to be considered these are: the tyre pressure and condition, the surface condition (if wet, icy or slippery, and this includes leaf cover and/or other debris, we advise against driving the slope), batteries charge and the weight of the user, all of these will affect performance.

Front brake lock lever:

Drive mode: Must be in the forward, locked position to engage motor (picture – below left).

Freewheel/motor bypass mode: Move lever out and rearwards to disengage front brake lock (picture – below right). This will disable the brake and enable freewheel/motor bypass mode, but you will still feel some resistance. If the eFOLDi is switched on there will be a continual warning sound from the bleeper.

Do NOT disengage brake lever whilst on hills or sloping ground - you will have to no form of braking available.



Drive



Freewheel

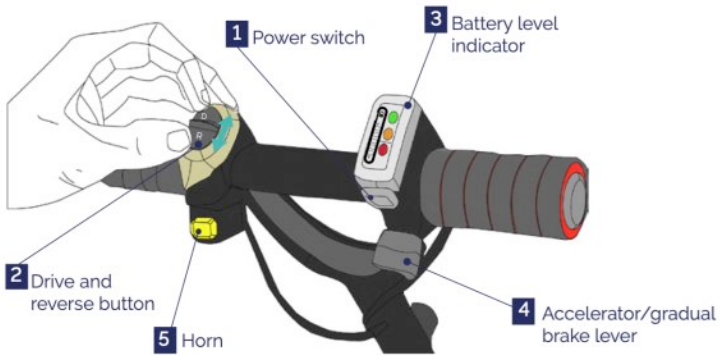

1	Power switch	2	Drive and reverse button
3	Battery level indicator	4	Accelerator/gradual brake lever
5	Horn		

Table 2: Model Lite Control bar

- Power switch (1) works by pushing the button underneath the battery level indicator and the battery indicator will illuminate.
- Drive and reverse button (2) works by pushing the button forward into the D position to Drive, R position to Reverse. **Change between D and R only works when the scooter is stationary.**
- Battery indicator (3) shows you how much battery there is left for usage. When the battery is fully charged all three lights will illuminate. When a single red light is shown the battery will soon need charging.
- Accelerator/gradual brake lever (4) is pressed the vehicle will drive, reaching a maximum speed of 4mph. The braking system will work gradually, as soon as the lever is released.
- Horn (5) works by pressing the yellow button under the drive and reverse button.



**Perform the safety check before each use
- see Safety Guidance section.**

Operating the scooter:

- To Start - Press the power switch (1) to turn on the scooter.
- Choose a gear - Choose the right gear by pushing the Drive/Reverse (2) button up or down to drive or reverse.
- To Drive/Reverse - Press the accelerator lever (4) to drive or reverse.

Make sure you do not put too much force on the steering column and handle bar, which may cause it to bend and loose steering efficiency.

- To Stop - Release the accelerator lever (4) to stop the scooter.

Please leave at least 1.5 meters between the scooter and obstacles on level ground. The stop distance on slopes can be significantly greater than on level ground.

Caution:

When travelling at speeds greater than a slow walking pace be sure to slow down before turning.

The stopping distance on slopes can be significantly greater than on level ground; The scooter surface temperatures can increase when exposed to external sources of heat (e.g. sunlight)

Battery and Charging



The eFOLDi Lite battery has been designed and built specifically for the model Lite. This battery must not be used for any purpose other than as stated in this manual. Any misuse or dismantling of this battery may damage it physically and/or electrically, internally and/or externally and will not be covered by warranty.

The battery contains no user serviceable or replaceable components.

The eFOLDi Lite battery is actually a battery pack, comprising a number of Lithium Ion cells, but merely termed 'battery' for ease throughout this manual. This battery is different in characteristics and charging requirements to quite common Lead acid or Lead gel type. Never use a Lead type charger to charge it.



To ensure best long-term use of the battery, please observe the following safety rules at all times.

- Connection dock must be handled with care to avoid damage.
- Charge the battery only with the approved charger.
- Never use a charger for lead acid type batteries on the eFOLDi battery.
- Never place the battery near, on or against any heat source.
- Ensure no metal parts can touch (or 'short') battery or charger terminals, connectors, pins or any other electrical conductor(s) or conducting parts.
- Avoid excessive physical impact and vibration of the battery.
- Do not attempt to dismantle, dissect or deform the battery(ies) or case(s).

- Do not immerse the battery in any liquid (including water).
- Keep the battery out of reach of children.
- Do not use modified or damaged chargers.
- Do not leave the battery on charge for more than 24 hours.
- Store the battery in a cool, dry, well ventilated area.
- Dispose of the battery only in accordance with local laws and regulations.
- If battery is not used often, it is preferable to give it a short 'top up' charge every 2-3 months.
- Never store the battery when it is significantly discharged.

Battery level indicator:

The battery level indicator is positioned on the handle bar and shows how much battery there is left for usage.

Meaning of light indication on battery:

- **Green, Orange and Red** : Battery is fully charged.
- **Orange and Red** : A medium level of battery is available.
- **Red**: Battery will soon need charging.

Fitting the battery into the eFOLDi :

The battery is positioned in the footrest of the eFOLDi Lite. To take out and charge the battery you have to lift the release lock and it will be instantly disengaged. Repeat the process in reverse making sure the battery clicks into place. For an efficient battery removal, make sure that the main power is switched off.

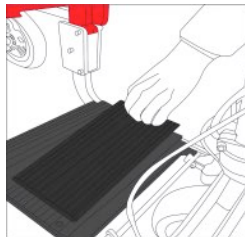

Charger and Charging

Precaution for use and handling charger

Use only the charger originally supplied with your new eFOLDi or replacement charger supplied by SunTech UK Ltd for the use with the eFOLDi. The use of a non-approved charger will invalidate any warranty and may cause serious damage to the battery and/or your eFOLDi. The charger should not be used with or for other devices as damage caused to the charger and/or any other device by doing so will not be covered by our warranty.

It is highly recommended to ensure the charger is placed only on heat resistant surfaces and nothing which could contribute to a fire (e.g. carpet, floorboards, wood, laminate or plastic worktops and so on) - the charger will heat up during a normal charging cycle, as will the battery.

Do not leave the battery on charge for more than 24 hours, as this will reduce the life and performance of the battery.

Charging notes for international travellers

For the benefit of international travellers, your approved eFOLDi charger can be used with any mains voltage supply from 100 to 240 Volts, with a suitable travel adaptor. However, lower mains voltage supply may cause longer charging times.

Using the charger

After the easy removal of the battery it can be charged up by plugging into the socket.



*Before obtaining an alternative cable, it is recommended you examine your eFOLDi charger to determine which type of plug it requires - it will be either a two-pin 'figure of 8' (IEC60320-1 C7), or a three-pin similar to a kettle (IEC60320-1 C13).

Checks and maintenance



Safety checks prior to using your eFOLDi.

- Check the correct tyre inflation and maintain without exceeding the P.S.I./BAR/kPa air pressure rating indicated on each pneumatic tyre.
- Check and test the brakes and make sure all the parts of the brakes are working properly.
- Check the fastening condition of each nuts, bolts and screws to make sure all the parts are properly secured and are not missing or loose.
- Check all electrical connections. Make sure they are tight and not corroded.
- Check the battery is sufficiently charged.

Cleaning and maintenance:

Periodic cleaning of your eFOLDi will help to maintain its appearance and will both extend the life of the vehicle and improve resale value. Metal and plastic parts can be wiped with a damp cloth using a mild detergent. Use a soft lint free cloth to polish.



Kind reminder:

Contact your dealer or us to have your eFOLDi regularly serviced each year.

Technical specification/EMC declaration

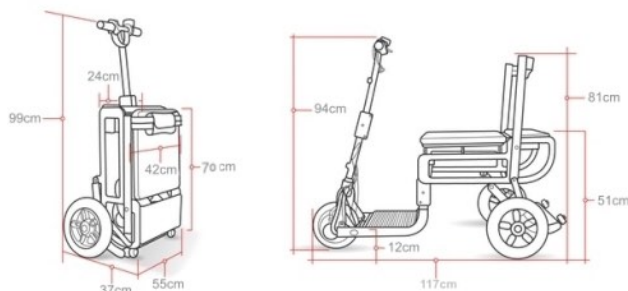

Frame material:	Magnesium Alloy
Dimension:	
Packaging size (L/W/H):	59x44x77cm (23x17x30inch)
Folded size (L/W/H):	70x55x37cm (27.5x22x15inch)
Unfolded size (L/W/H):	117x55x94cm (46x22x37inch)
Seat height:	51cm (20inch)
Footrest height:	12cm (4.7inch)
Front wheel size:	20cm (8inch)
Rear wheel size:	25cm (10inch)
Ground clearance:	7cm (2.7inch)
Weight:	
Weight with battery:	17kg (38lbs)
Weight without battery:	15kg (33lbs)
Performance:	
Place to use:	Pavement and indoor
Speed:	4mph (6kmh)
Maximum carry capacity:	120kg (265lbs/19st)
Maximum Incline:	1:10 Gradient (6 degrees)
Turning radius	100 (40inch)
Maximum kerb height:	4cm (1.5inch)
Components capability:	
Motor:	180W, 24VDC Hub motor
Battery:	24VDC, 10Ah Lithium Ion , 240Wh
Charger:	Input 110-220VAC, 50/60Hz, output 29.4V 2A
Full charge range capacity:	10miles (16km)
Brake:	Electric magnetic
Main Switch:	Push button
Lights:	No
Number of Wheels:	3

Table 3: Specification-Scooter-Lite

EMC Guidance and Manufacturer's Declaration

Below cable information are provided for EMC reference.

Cable	Max. cable length, Shielded/unshielded		Number	Cable classificatio
AC Power Line	1.5m	Unshielded	1 Set	AC Power
DC Power Line	1.5m	Unshielded	1 Set	DC Power

Important information regarding Electro Magnetic Compatibility (EMC)

This electrical medical equipment needs special precautions regarding EMC and put into service according to the EMC information provided in the user manual; The equipment conforms to this IEC 60601-1-2:2014 standard for both immunity and emissions. Nevertheless, special precautions need to be observed:

The equipment with Following **ESSENTIAL PERFORMANCE** is intended used in home healthcare environment.

ESSENTIAL PERFORMANCE:

The average wheel speed of the scooter is not able to change, exceeding $\pm 20\%$

WARNING: Use of this equipment adjacent to or stacked with other equipment should be avoided because it could result in improper operation.

If such use is necessary, this equipment and the other equipment should be observed to verify that they are operating normally.

The use of accessories, transducers and cables other than those specified or provided by the manufacturer of this equipment could result in increased electromagnetic emissions or decreased electromagnetic immunity of this equipment and result in improper operation.

WARNING: Portable RF communications equipment (including peripherals such as antenna cables and external antennas) should be used no closer than 30 cm (12 inches) to any part of this product, including cables specified by the manufacturer. Otherwise, degradation of the performance of this equipment could result.

WARNING: If the use location is near (e.g. less than 1.5 km from) AM, FM or TV broadcast antennas, before using this equipment, it should be observed to verify that it is operating normally to assure that the equipment remains safe with regard to electromagnetic disturbances throughout the expected service life.

Test	Power input voltage	Power frequency	Remark
Conducted DISTURBANCES (Conducted EMISSIONS) CISPR 11	AC 100V AC 240V	60Hz 50Hz	Charger
Electromagnetic radiation disturbance (Radiated EMISSIONS) CISPR 11	AC 100V AC 240V DC 24V	60Hz 50Hz	Charger Battery
Harmonic current EMISSIONS IEC 61000-3-2	AC 230V	50Hz	Charger
Voltage changes, voltage fluctuations and flicker EMISSIONS IEC 61000-3-3	AC 230V	50Hz	Charger
ELECTROSTATIC DISCHARGE IMMUNITY IEC 61000-4-2	AC 230V DC 24V	50Hz	Charger Battery
Radiated RF electromagnetic field IMMUNITY IEC 61000-4-3	AC 230V DC 24V	50Hz	Charger Battery
IMMUNITY to proximity fields from RF wireless communications equipment IEC 61000-4-3 (interim method)	AC 230V DC 24V	50Hz	Charger Battery
Electrical fast transient/burst IMMUNITY – a.c. mains IEC 61000-4-4	AC 230V	50Hz	Charger
Electrical fast transient/burst IMMUNITY– I/O SIP/SOP PORTS IEC 61000-4-4	N/A	N/A	N/A
Surge IMMUNITY IEC 61000-4-5	AC 230V	50Hz	Charger

IMMUNITY to conducted DISTURBANCES induced by RF fields conducted RF DISTURBANCE IMMUNITY) – a.c. mains IEC 61000-4-6	AC 230V	50Hz	Charger
IMMUNITY to conducted DISTURBANCES induced by RF fields (conducted Disturbance IMMUNITY) – SIP/SOP PORTS IEC 61000-4-6	AC 230V	50Hz	Charger
Power frequency magnetic field IMMUNITY IEC 61000-4-8	AC 230V DC 24V	50/60Hz	Charger Battery
Voltage dips IMMUNITY IEC 61000-4-11	AC 100V AC 240V	50Hz 50Hz	Charger
Voltage short interruptions and voltage variations IMMUNITY IEC 61000-4-11	AC 100V AC 240V	50Hz 50Hz	Charger

Table 3: Power input voltages and frequencies during the tests

EMI Compliance Table (Table 4)

Phenomenon	Compliance	Electromagnetic environment
RF emissions	CISPR 11 Group 1, Class B	Home healthcare environment
Harmonic distortion	IEC 61000-3-2 Class A	Home healthcare environment
Voltage fluctuations and flicker	IEC 61000-3-3 Compliance	Home healthcare environment

Table 4: Emission

EMS Compliance Table (Table 5-8):

Phenomenon	Basic EMC standard	Immunity test levels
		Home healthcare environment
Electrostatic Discharge	IEC 61000-4-2	±2kV, ±4kV, ±6kV, ±8 kV contact ±2kV, ±4kV, ±8kV, ±15kV air
Radiated RF EM field	IEC 61000-4-3	20V/m 26MHz-2.7GHz 80% AM at 1kHz
Proximity fields from RF wireless communications equipment	IEC 61000-4-3	Refer to table 3
Rated power frequency magnetic fields	IEC 61000-4-8	30A/m 50Hz or 60Hz

Table 5: Enclosure port

Test frequency (MHz)	Band (MHz)	Immunity test levels
		Home healthcare environment
385	380-390	Pulse modulation 18Hz, 27V/m
450	430-470	Pulse modulation 18Hz, 28V/m
710	704-787	Pulse modulation 217Hz, 9V/m
745		
780		
810	800-960	Pulse modulation 18Hz, 28V/m
870		
930		
1720	1700-1990	Pulse modulation 217Hz, 28V/m
1845		
1970		
2450	2400-2570	Pulse modulation 217Hz, 28V/m
5240	5100-5800	Pulse modulation 217Hz, 9V/m
5500		
5785		

Table 6: Proximity fields from RF wireless communications equipment

Phenomenon	Basic EMC standard	Immunity test levels
		Home healthcare environment
Electrical fast transients/burst	IEC 61000-4-4	±2 kV 100kHz repetition frequency
Surges Line-to-line	IEC 61000-4-5	±0.5 kV, ±1 kV
Conducted disturbances induced by RF fields	IEC 61000-4-6	3V, 0.15MHz-80MHz 6V in ISM bands and amateur radio bands between 0.15MHz and 80MHz 80%AM at 1kHz
Voltage dips	IEC 61000-4-11	0% UT; 0.5 cycle At 0°, 45°, 90°, 135°, 180°, 225°, 270° and 315°
		0% UT; 1 cycle, and 70% UT; 25/30 cycles Single phase: at 0°
Voltage interruptions	IEC 61000-4-11	0% UT, 250/300 cycles

Table 7: Input a.c. power Port

Phenomenon	Basic EMC standard	Immunity test levels
		Home healthcare environment
Conducted disturbances induced by RF fields	IEC 61000-4-6	3V, 0.15MHz-80MHz 6V in ISM bands and amateur radio bands between 0.15MHz and 80MHz 80% AM at 1kHz

Table 8: Signal input/output parts port

Appendix



SunTech UK Ltd

25 Ormside Way, Holmethrope Industrial Estate, Redhill, Surrey,
RH1 2LW





TEL: +44 (0) 2031435168



MedPath GmbH

Mies-van-der-Rohe-Strasse 8, 80807 Munich, Germany

Symbols used on the label

	European CE Marking		Manufacturer			
<table border="1"><tr><td>EC</td><td>REP</td></tr></table>	EC	REP	Authorized representative in the European community	<table border="1"><tr><td>MD</td></tr></table>	MD	Medical device
EC	REP					
MD						
<table border="1"><tr><td>SN</td></tr></table>	SN	Serial number	<table border="1"><tr><td>UDI</td></tr></table>	UDI	Unique Device Identification	
SN						
UDI						
	Date of manufacture		Refer to instructions manual			
	No trash bin	UK CA	UK Conformity Assessed			



(eFOLDi accessories)
www.efoldi.com/shop



SunTech UK Ltd
25 Ormside Way, Redhill,
Surrey, RH1 2LW, UK



MedPath GmbH
Mies-van-der-Rohe-Strasse 8
80807 Munich, Germany



Official website address: www.efoldi.com
Service email: services@efoldi.com
Facebook: www.facebook.com/efoldi.co.uk