

# BEDS

**drive**<sup>TM</sup>

# & ACCESSORIES 2014

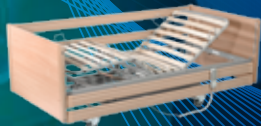

Profiling Beds



Options & Accessories



Mattresses



Hoists & Slings

**casabeds**<sup>TM</sup>  
By **drive**

**This essential catalogue from Drive Medical is brimming with solutions to aid independence, comfort and safety.**

Each page is packed with innovative products that really make a difference, from high specification profiling beds to accessories for the bedroom.

Every product is carefully designed to help managers and owners maintain high standards of practice and improve the working environment for staff, helping them to work safer, easier and quicker.

Drive Medical is dedicated to bringing you the very best products through design and engineering excellence.

User focused, market leading solutions for long-term care



# Contents

<b>Benefits of four-section profiling</b>	<b>4-5</b>
<b>Profiling Beds</b>	<b>6-30</b>
Casa Med Classic FS with Integral Side Rails	6-7
Casa Med Classic FS Low with Integral Side Rails	8-9
Casa Med Classic FS Low	10-11
Auto Regression Mattress Support	12-13
Casa Med Ultra FS with Integral Side Rails	14-15
Casa Med SE Low	16-17
Casa Med SE Deluxe with Integral Side Rails	18-19
Casa Med II with Integral Side Rails	20-21
Casa Nuova II & Casa Nuova II Low	22
Casa Nuova III & Casa Nuova III Low	23
Casa Nuova with Auto Regression Backrest	24
Casa Nuova Ultra	25
Casa Med Bariatric	26
What positioning options do CasaBeds offer?	27
A-Z Features	29-30
<b>Options &amp; Accessories</b>	<b>31-39</b>
Handset Options	31
Trendelenburg Kit	32
Bed Rails	33
Rails for Profiling Beds & Extension Rails	34
Bed Rails & Clamps	35
Cot Bumpers	36
Other Accessories for Profiling Beds	37-38
Bedside Cabinets	39
<b>Mattresses</b>	<b>40-46</b>
Importance of Mattress Selection	40
Introducing Casa Mattresses	41
Introducing Prima & Closure Mattresse Covers	42
Tri-Flex Mattresses	43
Wide Heavy Duty Bariatric Mattresses	44
Introducing Safety Floor Mattresses	45
Mattress Accessories	46
<b>Care &amp; Maintenance</b>	<b>47-48</b>
<b>Handling &amp; Moving Equipment</b>	<b>49-55</b>
Mobile Hoist	49-50
Slings	51-52
Ambiturn Sit to Stand Transfer Aid	53
Ablestand Patient Turner	54
Solo Toilet Lift	55

# Benefits of four-section profiling



## For Users

- Wide range of positioning options
- Significantly reduces the risk of pressure ulcer development
- Assists fluid drainage and poor venous return
- Improves general well-being through increased independence and comfort
- Easier and safer side transfer
- Integrated side rails can be lowered below the mattress for comfort when transferring
- Easy to use handset with raised buttons for ease of identification

Improved comfort and independence



## For Nursing Home Owners/Facilities Managers

- High quality and functionality, and competitively priced
- Appealing to prospective residents
- A safer working environment with fewer strain injuries to staff
- Assembled in the UK to ensure strict adherence to quality control standards
- Interchangeable key components, enabling parts to be taken off a spare bed and used on another
- To ensure rails on beds without integral rails are fitted in compliance to BS EN 60601-2-52 : 2010 to prevent entrapment, there is an easy to understand rail safety setting label on the bed
- CE marked to current EU medical directive standards
- All integrated rails are fitted with safety end caps and act as an integral braking system to prevent entrapment when lowering and raising the rails. They are also compliant with BS EN 60601-2-52 : 2010
- Easy to clean and disinfect, therefore reducing the risk of cross-contamination
- Increases nurses' productivity
- Bed Extension kits available to fit users from 196 to 216cm/6' 5" to 7' 1"
- 3 year warranty

Easy to clean



### For Carers and Nursing Staff

- Helps prevent back injuries caused by lifting, turning or moving the bed occupant
- Reduced nursing time
- Easier and safer side transfer
- Easier and more effective prevention and management of pressure sores
- Manual and electric leg height adjustment, for maximum patient comfort
- Quick and easy to assemble with no tools required
- Only two motors to attach to the bed. The lift motors are pre-installed at the head and foot boards
- Interchangeable colour-coded plugs and sockets to ensure they are quick and easy to fit
- Clear diagrams on the bed showing actuator orientation
- Transportation bracket for ease of transportation and compact storage
- Quick-release pins on the actuator for ease and speed of assembling and disassembling
- Cable management system with cable tensioning to ensure all cables are kept off the floor
- Two point (left and right side) handset cable positioning for convenience and comfort
- All integrated rails are fitted with safety end caps and act as an integral braking system to prevent entrapment when lowering and raising the rails. They are also compliant with BS EN 60601-2-52 : 2010
- Twin-axle low gravity brake castors on low beds to maintain ease of manoeuvrability
- To ensure rails on beds without integral rails are fitted in compliance to BS EN 60601-2-52 : 2010 to prevent entrapment, there is an easy to understand rail safety setting label on the bed

Reduced nursing time



### For Community Equipment Loan Store Managers

- Fast installation by person (tool-free assembly)
- High quality and functionality, competitively priced
- Assembled in the UK to ensure strict adherence to quality control standards
- Interchangeable key components, enabling parts to be taken off a spare bed and used on another
- To ensure rails on beds without integral rails are fitted in compliance to BS EN 60601-2-52 : 2010 to prevent entrapment, there is an easy to understand rail safety setting label on the bed
- CE marked to current EU medical directive standards
- All integrated rails are fitted with safety end caps and act as an integral braking system to prevent entrapment when lowering and raising the rails. They are also compliant with BS EN 60601-2-52 : 2010
- Easy to clean and disinfect, therefore reducing the risk of cross-contamination
- Bed Extension kits available to fit users from 196 to 216cm/6'5" to 7'1"
- 3 year warranty
- 10 year warranty on metal steel tube mattress support

Fast to install

# Casa Med Classic FS with Integral Side Rails

Offering an attractive and non-clinical finish, this best-selling bed is beautifully finished with enclosed motors and curved beech-effect head and foot board. Alternative colours are available in maple, oak or walnut. The standard height bed 40cm - 80cm enables carers/nurses to care for users successfully, without bending and causing back injuries.



## Features & Benefits

- Dewert motor, handset and controls, 8 button handset
- Dual motor headrest and knee brake adjustment
- Electric backrest, leg rest, knee brake and lower leg elevation
- Emergency lowering by quick action bolt mechanism
- Four brake castors (100mm)
- Four-section mattress support
- Quick-release pins on all actuator points
- Extra high side rails available – see page 34
- Tool-free assembling and dismantling
- Transport system and lock

## Technical Specifications

- Total Weight (4-piece) 91.5kg
- Heaviest Part 20.1kg
- Outer Dimensions (W×L) 102.3×212.5cm
- Maximum Safe Working Load 175kg
- Height Adjustment 40-80cm
- Adjustment Angle of Back Section 0°-70°
- Adjustment Angle of Foot Section 0°-20°

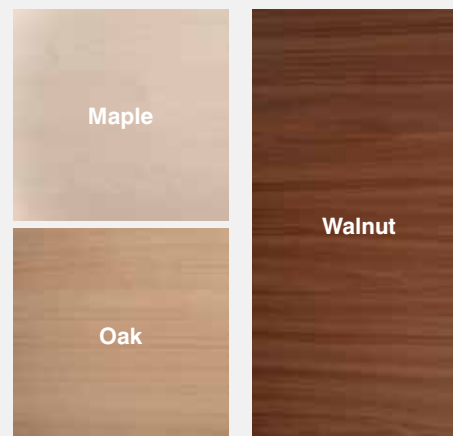

Maximum User Weight

## Ordering Details

Product Code	Bed	Headboards	Height Adj.	Mattress Support
19849SED3 BE	Casa Med Classic FS - with integral side rails	Beech	40 - 80cm	Metal Mesh
19847SED3 BE	Casa Med Classic FS - with integral side rails	Beech	40 - 80cm	Wooden Slat
19849SC4ED3 BE	Casa Med Classic FS - with integral side rails	Maple	40 - 80cm	Metal Mesh
19849SC5ED3 BE	Casa Med Classic FS - with integral side rails	Walnut	40 - 80cm	Metal Mesh
19849SC6ED3 BE	Casa Med Classic FS - with integral side rails	Oak	40 - 80cm	Metal Mesh



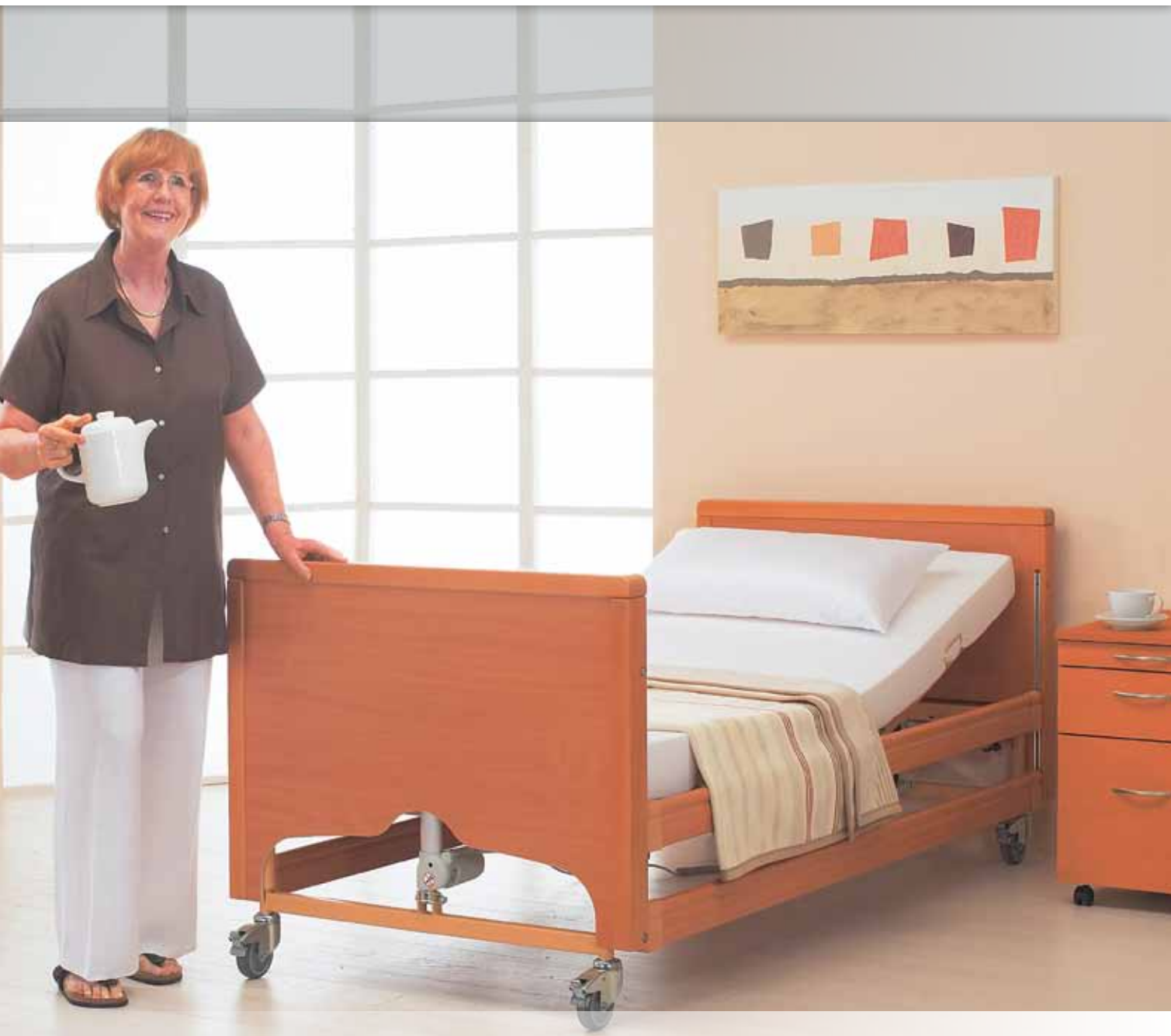

# Casa Med Classic FS Low with Integral Side Rails

The Casa Med Classic Low offers attractive styling with the added benefit of integral side rails that are fully compliant to BS standards. The combination of low positioning and integral side rails ensures a safe resting and sleeping environment for those at risk of falling out of bed, providing the highest levels of safety standards. Alternative colours are available in maple, oak or walnut.



## Features & Benefits

- Dewert motor, handset and controls, 8 button handset
- Dual motor headrest and knee brake adjustment
- Electric backrest, leg rest, knee brake and lower leg elevation
- Emergency lowering by quick action bolt mechanism
- Four brake castors (50mm) double
- Four-section mattress support
- Quick-release pins on all actuator points
- Extra high side rails available – see page 34
- Tool-free assembling and dismantling
- Transport system and lock

## Technical Specifications

- Total Weight (3-piece) **97.8kg**
- Heaviest Part **25.4kg**
- Maximum Working Load **175kg**
- Outer Dimensions (W×L) **102.3×213.5cm**
- Height Adjustment **23-63cm**
- Adjustment Angle of Back Section **0°-70°**
- Adjustment Angle of Foot Section **0°-20°**

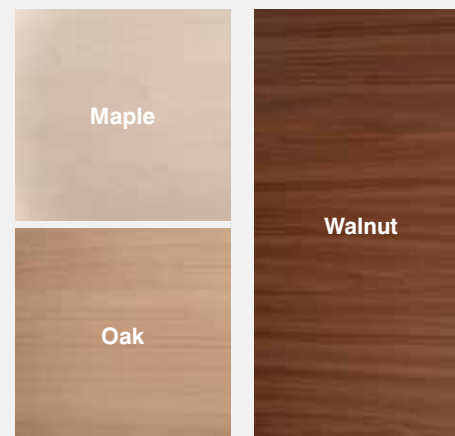

## Ordering Details

Product Code	Bed	Headboards	Height Adj.	Mattress Support
10156SWRED3 BE	Casa Med Classic FS Low - with integral side rails	Beech	23 - 63cm	Metal Mesh
10157SWRED3 BE	Casa Med Classic FS Low - with integral side rails	Beech	23 - 63cm	Wooden Slat
10156SWRC4ED3 BE	Casa Med Classic FS Low - with integral side rails	Maple	23 - 63cm	Metal Mesh
10156SWRC5ED3 BE	Casa Med Classic FS Low - with integral side rails	Walnut	23 - 63cm	Metal Mesh
10156SWRC6ED3 BE	Casa Med Classic FS Low - with integral side rails	Oak	23 - 63cm	Metal Mesh



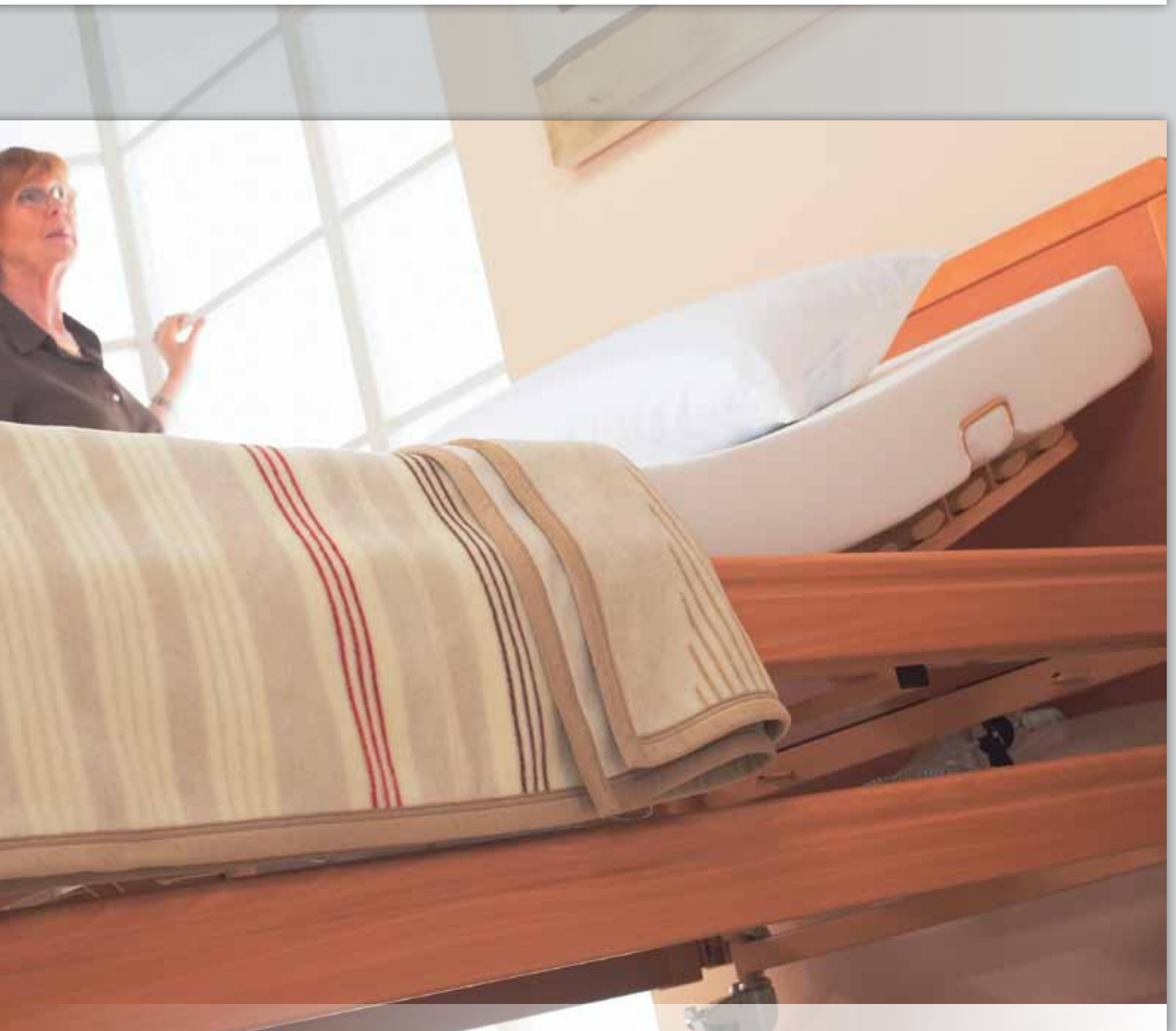

# Casa Med Classic FS Low

The Casa Med Classic FS Low brightens up any room with its classic design and attractive natural beech-effect head and foot boards. Its low positioning ensures a safe resting and sleeping environment for users at risk of falling out of bed. Folding side rails can be purchased separately. To ensure the rails are fitted in compliance to BS standards to prevent entrapment, there is an easy to understand rail safety setting label on the bed.



## Features & Benefits

- Dewert motor, handset and controls, 8 button handset
- Dual motor headrest and knee brake adjustment
- Electric backrest, leg rest, knee brake and lower leg elevation
- Emergency lowering by quick action bolt mechanism
- Four brake castors (75mm) double
- Four-section mattress support
- Quick-release pins on all actuator points
- Extra high side rails available – see page 34
- Tool-free assembling and dismantling
- Transport system and lock

## Technical Specifications

- Total Weight (3-piece) 97.8kg
- Heaviest Part 25.4kg
- Maximum Working Load 175kg
- Outer Dimensions (W×L) 102.3×213.5cm
- Height Adjustment 23-63cm
- Adjustment Angle of Back Section 0°-70°
- Adjustment Angle of Foot Section 0°-20°



Maximum User Weight

## Ordering Details

Product Code	Bed	Headboards	Height Adj.	Mattress Support
10156SED3 BE	Casa Med Classic FS Low	Beech	23 - 63cm	Metal Mesh
10157SED3 BE	Casa Med Classic FS Low	Beech	23 - 63cm	Wooden Slat



# Auto Regression Mattress Support

Our latest ultra modern design mattress support is manufactured from robust steel tubing and incorporates an auto regression backrest.



## Features & Benefits

- Dewert motor, handset and controls
- Dual motor headrest and knee brake adjustment
- Electric backrest, leg rest, knee brake and lower leg elevation
- Emergency lowering by quick action bolt mechanism
- Four brake castors
- Four-section metal steel tube mattress support
- Quick-release pins on all actuator points
- Tool-free assembling and dismantling
- Transport system and lock
- Integral bed extension (22cm)
- Choice of wooden or metal side rails

## Technical Specifications

- Total Weight (4-piece) **91.5kg**
- Heaviest Part **20.1kg**
- Outer Dimensions (W×L) **102.3×234.5cm**
- Maximum Safe Working Load **200kg**
- Height Adjustment **40-80cm**
- Adjustment Angle of Back Section **0°-70°**
- Adjustment Angle of Foot Section **0°-20°**



Maximum User Weight



## Ordering Details

### Product Code

19849SAMED3 BE  
10156SWAMED3 BE  
19849SAED3 BE  
10156SWRAED3 BE

### Bed

Casa Med Classic FS - with integral metal side rails - Auto Regression  
Casa Med Classic FS Low - with integral metal side rails - Auto Regression  
Casa Med Classic FS - with integral wooden side rails - Auto Regression  
Casa Med Classic FS Low - with integral wooden side rails - Auto Regression

### Headboards

Beech  
Beech  
Beech  
Beech

### Height Adj.

40 - 80cm  
23 - 63cm  
40 - 80cm  
23 - 63cm

### Mattress Support

Metal Steel Tube  
Metal Steel Tube  
Metal Steel Tube  
Metal Steel Tube





# Casa Med Ultra FS with Integral Side Rails

The Casa Med Ultra FS is a competitively priced entry-level bed with all the high levels of functionality you would expect from a Casa Med bed. It also comes with attractive beech-effect head and foot board to create a comforting environment.



## Features & Benefits

- Dewert motor, handset and controls, 8 button handset
- Dual motor headrest and knee brake adjustment
- Electric backrest, leg rest, knee brake and lower leg elevation
- Emergency lowering by quick action bolt mechanism
- Four brake castors
- Four-section mattress support
- Quick-release pins on all actuator points
- Extra high side rails available – see page 34
- Tool-free assembling and dismantling
- Transport system and lock

## Technical Specifications

- Total Weight (4-piece) 91.5kg
- Heaviest Part 20.1kg
- Outer Dimensions (W×L) 102.3×212.5cm
- Maximum Safe Working Load 175kg
- Height Adjustment 40-80cm
- Adjustment Angle of Back Section 0°-70°
- Adjustment Angle of Foot Section 0°-20°



**140 kg** **22 st**  
Maximum User Weight

## Ordering Details

**Product Code**  
19909SED3 BE  
19908SED3 BE

**Bed**  
Casa Med Ultra FS - with integral side rails  
Casa Med Ultra FS - with integral side rails

**Headboards**  
Beech  
Beech

**Height Adj.**  
40 - 80cm  
40 - 80cm

**Mattress Support**  
Metal Mesh  
Wooden Slat





# Casa Med SE Low

With its beautifully finished beech-effect curved head and foot boards, the Casa Med SE Low is ideal for creating a homely feel. Its low positioning ensures a safe resting and sleeping environment for users at risk of falling out of bed. Folding side rails can be purchased separately. To ensure the rails are fitted in compliance to BS standards to prevent entrapment, there is an easy to understand rail safety setting label on the bed.



## Features & Benefits

- Dewert motor, handset and controls, 8 button handset
- Dual motor headrest and knee brake adjustment
- Electric backrest, leg rest, knee brake and lower leg elevation
- Emergency lowering by quick action bolt mechanism
- Four brake castors
- Four-section mattress support
- Extra high side rails available – see page 34
- Tool-free assembling and dismantling
- Transport system and lock

## Technical Specifications

- Total Weight (3-piece) **97.8kg**
- Heaviest Part **25.4kg**
- Maximum Working Load **175kg**
- Outer Dimensions (W×L) **91×213.5cm**
- Height Adjustment **23-63cm**
- Adjustment Angle of Back Section **0°-70°**
- Adjustment Angle of Foot Section **0°-20°**



**140 kg** **22 st**  
Maximum User Weight

## Ordering Details

Product Code	Bed	Headboards	Height Adj.	Mattress Support
22036ED3 BE	Casa Med SE Low	Beech	23 - 63cm	Metal Mesh
22037ED3 BE	Casa Med SE Low	Beech	23 - 63cm	Wooden Slat



# Casa Med SE Deluxe with Integral Side Rails

With its beautifully finished beech-effect head and foot boards, the Casa Med SE Deluxe is ideal for creating a homely feel. The positioning height of the bed is 40-80cm and offers the Carer a safer working environment with fewer strain injuries to staff. Integral wooden side rails are supplied as standard for additional safety. A patient pole can be purchased as an optional extra.



## Features & Benefits

- Dewert motor, handset and controls
- Dual motor headrest and knee brake adjustment
- Electric backrest, leg rest, knee brake and lower leg elevation
- Emergency lowering by quick action bolt mechanism
- Four brake castors
- Four section mattress support (Metal Mesh)
- Quick release pins on all actuator points
- Wooden integral side rails
- Extra high side rails available – see page 34
- Patient helper optional extra
- Tool free assembly and dismantling
- Transport system and lock

## Technical Specifications

- Total Weight (3 piece) **118kg**
- Heaviest Part **25.4kg**
- Maximum Working Load **175kg**
- Outer Dimensions (W×L) **103.3×213.5cm**
- Height Adjustment **40-80cm**
- Adjustment Angle of Back Section **0°-70°**
- Adjustment Angle of Foot Section **0°-20°**

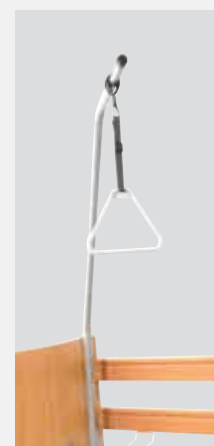
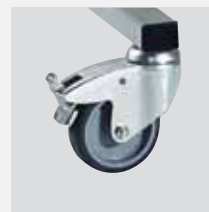

**140 kg** **22 st**  
Maximum User Weight

## Ordering Details

**Product Code**  
22035UKED3 BE

**Bed**  
Casa Med SE Deluxe - with integral side rails

**Headboards**  
Beech

**Height Adj.**  
40 - 80cm

**Mattress Support**  
Metal Mesh



# Casa Med II with Integral Side Rails

The Casa Med II is elegantly finished with fully enclosed motors and real wood head and foot boards. Offers additional scissor-lift raising mechanism to provide greater lifting stability and an increased safe working load.



## Features & Benefits

- Dewert motor, handset and controls
- Dual motor headrest and knee brake adjustment
- Electric backrest, leg rest, knee brake and lower leg elevation
- Emergency lowering by quick action bolt mechanism
- Four brake castors
- Four-section mattress support
- Quick-release pins on all actuator points
- Extra high side rails available – see page 34
- Tool-free assembling and dismantling
- Transport system and lock

## Technical Specifications

- Total Weight (4-piece) **149kg**
- Heaviest Part **40kg**
- Maximum Working Load **200kg**
- Mattress Base Height **40-80cm**
- Raising Mechanism Total Height **181.5cm**
- Overall Size (W×L) **101.2×206cm**
- Mattress Support (W×L) **89×199cm**
- Adjusting Angle - Back Section **0°-70°**
- Adjusting Angle - Lower Leg Section **0°-20°**
- Materials:  
End Panels - **Natural mock beech wood**  
Bed Frame - **Powder Coated Steel**



Maximum User Weight



## Ordering Details

**Product Code**  
21871ED3 BE  
19865ED3 BE

**Bed**  
Casa Med II - with integral side rails  
Casa Med II - with integral side rails

**Headboards**  
Beech  
Beech

**Height Adj.**  
40 - 80cm  
40 - 80cm

**Mattress Support**  
Metal Mesh  
Wooden Slat





# Casa Nuova II & Casa Nuova II Low

Casa Nuova II is very robust and stable. A key feature of this design provides a bed that's quicker to decontaminate after each patient use, ensuring cross-contamination is kept to an absolute minimum. Casa Nuova II is easily transported using our transport system and can be stored in an upright position maximising on storage space.



## Features & Benefits

- Easy to clean
- Easy to install & reinstall
- Fixed frame very robust and stable
- No tools required for assembly
- Transport bracket aids storage and transportation
- Quick release Dewert motors and control system
- Dewert lockable handset with head tilt as standard
- Detachable end actuator cable to control box connector
- Height adjustable
- Electric backrest, legrest and knee brake
- Dual action headrest and knee brake adjustment on handset, to help reduce shear when profiling
- Manual lower leg section levelling device
- 4 brake castors
- 4-section mattress support, 2 motor adjustments, separate for transport
- Three Year Warranty (Parts only)
- Ten Year Warranty - Metal steel tubes mattress supports (Parts only)

## Technical Specifications

- Total Weight **87.6kg**
- Heaviest Part **21.2kg**
- Outer Dimensions (W×L) **102×213cm**
- Maximum Safe Working Load **200kg**
- Maximum Patient Weight **180kg/28st**
- Height Adjustment **40-80cm or 23-63cm**



**180 kg** **28 st**  
Maximum User Weight

## Ordering Details

**Product Code**  
**21984ED3 BE**  
**21985ED3 BE**  
**21986ED3 BE**  
**21987ED3 BE**

### Bed

Casa Nuova II - reverse trendelenburg  
 Casa Nuova II - full trendelenburg  
 Casa Nuova II Low - reverse trendelenburg  
 Casa Nuova II Low - full trendelenburg

### Headboards

Beech  
 Beech  
 Beech  
 Beech

### Height Adj.

40 - 80cm  
 40 - 80cm  
 23 - 63cm  
 23 - 63cm

### Mattress Support

Metal Steel Tube  
 Metal Steel Tube  
 Metal Steel Tube  
 Metal Steel Tube



# Casa Nuova III & Casa Nuova III Low

The Casa Nuova III has been designed to provide a bed that is fast and easy to assemble, without using any tools. The bed is easily transported using our transport system and can be stored in an upright position, maximising storage space. The 4 section mattress support is manufactured from robust metal steel tube, which makes it easy to clean and disinfect. Actuators are pre-assembled to speed up installation time.



The Casa Nuova III can be supplied with optional clamp on rails or integral side rails as standard.



## Features & Benefits

- Easy to clean
- Easy to install & reinstall
- Fixed frame very robust and stable
- No tools required for assembly
- Transport bracket aids storage and transportation
- Quick release Dewert motors and control system
- Dewert lockable handset with head tilt as standard
- Detachable end actuator cable to control box connector
- Height adjustable
- Electric backrest, legrest and knee brake
- Dual action headrest and knee brake adjustment on handset, to help reduce shear when profiling
- Manual lower leg section levelling device
- 100mm diameter, 4 brake castors
- 4-section mattress support, 2 motor adjustments, separate for transport
- Three Year Warranty (Parts only)
- Ten Year Warranty - Metal steel tubes/mattress supports (Parts only)

## Technical Specifications

- Total Weight **80kg**
- Heaviest Part **24kg**
- Outer Dimensions (W×L) **102×213cm**
- Maximum Safe Working Load **200kg**
- Maximum Patient Weight **180kg/28st**
- Height Adjustment (21990) **40-80cm**
- Height Adjustment (21991) **23-63cm**

10 year warranty (Metal steel tube mattress supports & posts) (Parts only) on condition that the bed has been fully serviced.  
10 year warranty excludes: Electrics/wooden parts/castors & fittings



Maximum User Weight

## Ordering Details

Product Code	Bed	Headboards	Height Adj.	Mattress Support
21990 BE	Casa Nuova III - reverse trendelenburg, pre-assembled actuators	Beech	40 - 80cm	Metal Steel Tube
21991 BE	Casa Nuova III Low - reverse trendelenburg, pre-assembled actuators	Beech	23 - 63cm	Metal Steel Tube
21990WR BE	Casa Nuova III - reverse trendelenburg, pre-assembled actuators, integral metal side rails	Beech	40 - 80cm	Metal Steel Tube
21991WR BE	Casa Nuova III Low - reverse trendelenburg, pre-assembled actuators, integral metal side rails	Beech	23 - 63cm	Metal Steel Tube

# Casa Nuova with auto regression backrest

Our latest ultra modern design mattress support incorporates an auto regression backrest and integral bed extension.



## Features & Benefits

- Easy to clean
- Easy to install & reinstall
- Fixed frame very robust and stable
- No tools required for assembly
- Transport bracket aids storage and transportation
- Quick release Dewert motors and control system
- Dewert lockable handset with head tilt as standard
- Detachable end actuator cable to control box connector
- Height adjustable
- Electric auto regression backrest, legrest and knee brake
- Dual action headrest and knee brake adjustment on handset, to help reduce shear when profiling
- Manual lower leg section levelling device
- 4 brake castors
- 4-section mattress support, 2 motor adjustments, separate for transport
- Integral bed extension
- Three Year Warranty (Parts only)
- Ten Year Warranty - Metal steel tubes mattress supports (Parts only)

## Technical Specifications

- Total Weight **87.6kg**
- Heaviest Part **21.2kg**
- Outer Dimensions (W×L) **102×235cm**
- Maximum Safe Working Load **200kg**
- Maximum Patient Weight **180kg/28st**
- Height Adjustment (21990A BE) **40-80cm**
- Height Adjustment (21991A BE) **23-63cm**



## Ordering Details

Product Code	Bed
<b>21990A BE</b>	Casa Nuova - with auto regression backrest
<b>21991A BE</b>	Casa Nuova Low - with auto regression backrest

Headboards	Height Adj.
Beech	40 - 80cm
Beech	23 - 63cm

Mattress Support
Metal Steel Tube
Metal Steel Tube

# Casa Nuova Ultra

The Casa Nuova Ultra has the benefits of a Community Bed. However, the attractive beech headboard makes this bed more homely.



Image shown with metal rails



## Features & Benefits

- Easy to clean
- Easy to install & reinstall
- Fixed frame very robust and stable
- No tools required for assembly
- Transport bracket aids storage and transportation
- Quick release Dewert motors and control system, reverse trendelenburg
- Dewert lockable handset with head tilt as standard, 9 button
- Detachable end actuator cable to control box connector
- Height adjustable (23-63cm or 40-80cm)
- Electric backrest, legrest and knee brake
- Dual action headrest and knee brake adjustment on handset, to help reduce shear when profiling
- Manual lower leg section levelling device
- 4 brake castors
- 4-section mattress support, 2 motor adjustments, separate for transport
- Three Year Warranty (Parts only)
- Ten Year Warranty - Metal steel tubes/mattress supports (Parts only)

## Technical Specifications

- Total Weight **80kg**
- Heaviest Part **24kg**
- Outer Dimensions (W×L) **102×213cm**
- Maximum Safe Working Load **200kg**
- Maximum Patient Weight **180kg/28st**

10 year warranty (Metal steel tube mattress supports & posts) (Parts only) on condition that the bed has been fully serviced.  
10 year warranty excludes: Electrics/wooden parts/castors & fittings



Maximum User Weight

## Ordering Details

Product Code	Bed	Headboards	Height Adj.	Mattress Support
21984UED3 BE	Casa Nuova Ultra - with integral metal side rails	Beech	40 - 80cm	Metal Steel Tube
21986UED3 BE	Casa Nuova Ultra Low - with integral metal side rails	Beech	23 - 63cm	Metal Steel Tube
21995 BE	Casa Nuova Ultra - with wooden integral rails, pre-assembled actuators	Beech	40 - 80cm	Metal Steel Tube
21996 BE	Casa Nuova Ultra Low - with wooden integral rails, pre-assembled actuators	Beech	23 - 63cm	Metal Steel Tube

# Casa Med Bariatric

The Casa Med Bariatric fully profiling bed is available in two styles:-  
 120cm wide bed with grey plastic headboards and the option of clamp or side rails or  
 120cm wide bed with ultra beech wooden headboards, complete with metal integral side rails.



## Features & Benefits

- Easy to clean
- Easy to install & reinstall
- Fixed frame very robust and stable
- No tools required for assembly
- Transport bracket aids storage and transportation
- Quick release Dewert motors and control system
- Dewert lockable handset with head tilt as standard
- Detachable end actuator cable to control box connector
- Height adjustable
- Electric backrest, legrest and knee brake
- Dual action headrest and knee brake adjustment on handset, to help reduce shear when profiling
- Manual lower leg section levelling device
- 100mm diameter, 4 brake castors
- 4-section mattress support, 2 motor adjustments, separate for transport
- Three Year Warranty (Parts only)
- Ten Year Warranty - Metal steel tubes/mattress supports (Parts only)

## Technical Specifications

- Total Weight **95kg**
- Outer Dimensions (W×L) **132×213cm**
- Maximum Safe Working Load **317kg/50st**
- Maximum Patient Weight **286kg/45st**
- Mattress Support (W×L) **120×213cm**



Maximum User Weight

## Ordering Details

### Product Code

21990B BE  
 21991B BE  
 21990BUltra BE  
 21991BUltra BE

### Bed

Casa Med Bariatric  
 Casa Med Bariatric Low  
 Casa Med Bariatric Ultra  
 Casa Med Bariatric Ultra Low

### Headboards

Grey Plastic  
 Grey Plastic  
 Beech  
 Beech

### Height Adj.

40 - 80cm  
 24 - 64cm  
 40 - 80cm  
 24 - 64cm

### Mattress Support

Metal Steel Tube  
 Metal Steel Tube  
 Metal Steel Tube  
 Metal Steel Tube

# What positioning options do CasaBeds offer?

## No Profiling



Users may not always want to have their legs or back elevated. If this is the case they can simply set the bed to its flat or almost flat position.

## Leg Elevation

Leg elevation helps to reduce fluid and pressure in your legs and ankles, making it an ideal position to soothe away aches and pains from tiredness or injury.

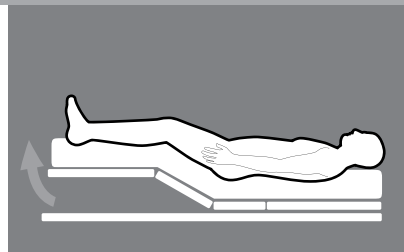

## Back Elevation

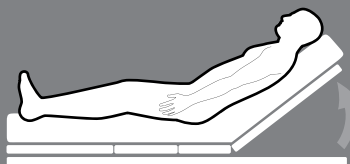

Back elevation offers great general positioning. CasaBeds can elevate your back by up to 70°, offering comfort and support for relaxing, reading, watching television or even eating in bed. Some people also find back elevation helps to relieve respiratory conditions.

## Back Elevation with Leg Elevation

This position enables users to achieve the benefits of both back and leg elevation. Back and leg elevation can also help users get into and out of bed safely and easily.

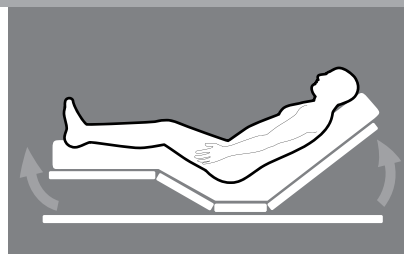

## Knee Brake



Allows the user to lie flat with the knees bent, offering additional support for the knee area.

## Back Elevation with Knee Brake

Offers great general positioning for the user, with comfort and support for the back and knee area.

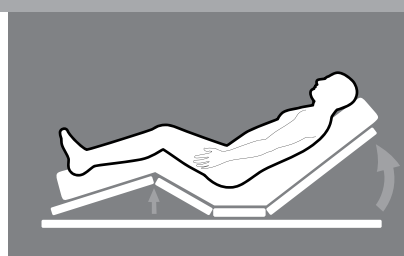

## Trendelenburg

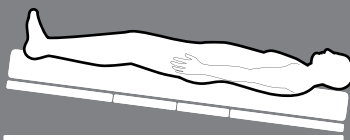

Allows the user's feet to be raised higher than the head, for a variety of medical purposes. Ideal for postural drainage, this position should only be used under professional supervision.

## Anti-Trendelenburg

This position provides added pressure relief for various areas of the body. Must only be used under medical supervision.

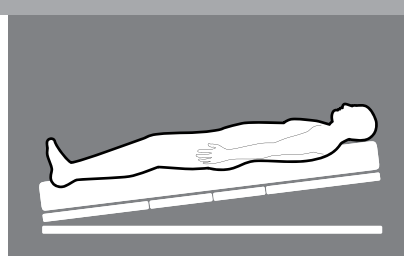

# A - Z CasaBed Features

Every CasaBed is supplied with the following features:

## 3 Year Warranty



Covering all electrical and non-electrical parts.

10 Year Warranty on Casa Nuova III (Page 21).

## 8 Function Handset



Offers back elevation, knee brake and lower leg elevation. An optional 8 function handset with magnetic swipe lock out is also available.

## 9 Function Handset (Optional)



Offers the same positioning as an 8 function handset, plus anti-Trendelenburg positioning. Also features magnetic swipe lock out.

## 10 Function Handset (Optional)



Offers full Trendelenburg positioning, when coupled with the Trendelenburg battery back-up kit. Also features magnetic swipe lock out.

## Compliance to BS Standards



All rails are fully compliant to BS EN 60601-2-52 : 2010 legal requirements to ensure a safe environment for both users and carers.

## Dewert Motor, Handset and Controls



All manufactured by this world leading supplier to ensure the highest levels of functionality and reliability.

All Dewert equipment comes with a 3 year warranty.

## Electric Backrest, Leg Rest, Knee Brake and Lower Leg Elevation



To enable the user to change positions independently, or allow a nurse or carer to reposition without manual effort.

The lower leg elevation can also be adjusted manually.

## Emergency Lowering by Quick Action Bolt Mechanism



The backrest motor can be quickly released should a cardio pulmonary resuscitation (CPR) position be required.

# A - Z CasaBed Features

Every CasaBed is supplied with the following features:

## Enclosed Motors



On selected models for an attractive and non-clinical effect.

## Extension Kit (Optional)



To fit users from 196 to 216 cm / 6'5" to 7'1".

## Four Brake Castors



For safety and manoeuvrability.

## Four-Section Mattress Support

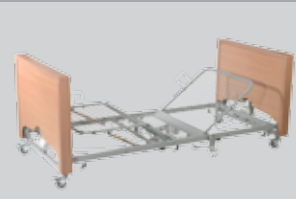

To offer a maximum range of positioning options.

## Handset Locking Facility to Maintain Position (Optional)



To prevent the user from being able to move the bed without the presence of a carer or nurse. A magnetic swipe key is required to activate.

## Low/High Height Adjustment



On low beds offer a safe sleeping and resting position, and enable the bed to be raised for ease of nursing.

## Maximised User Capacity



Casa Med II offer an increased user capacity of up to 165kg/25 stone.

Casa Nuova only – 180kg/28 stone.

## Patient Pole with Triangle (Optional)



To offer support for positioning when sitting or lying in bed.

## Quick-Release Pins on all Actuator Points



For ease and speed of assembling and dismantling.

## Rail Height Adjustment



To enable transfer in and out of bed and ensure the rails will drop lower than the mattress.



# A - Z CasaBed Features

Every CasaBed is supplied with the following features:

## Rail Safety Setting Label



For the low beds which do not have integral rails, there is a bed rail safety setting label on the bed to ensure it is fitted in compliance with BS standards to prevent entrapment.

## Real Wood Head and Foot Boards



Casa Med SE Low have attractive curved head and foot boards to ensure a premium quality finish.

## Safety End Caps and Braking System



Fitted to all integral rails to prevent entrapment when lowering and raising.

## Scissor Raising Mechanism



On Casa Med II to ensure maximum stability when lifting and provide a maximised user capacity.

## Side Rails



To offer a safe sleeping and resting environment. All standard height beds come with integrated side rails, and low height beds are available with or without integrated side rails.

## Tension Adjustable Wooden Mattress Support (Optional)



To adjust the mattress support from firm to soft, according to the user's needs.

## Trendelenburg Kit (Optional)



To redefine a standard profiling bed into a hospital bed.

## Transport System and Lock

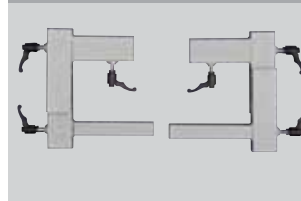

To enable the beds to be easily transported and stored compactly when not in use.

## Twin-Axle Low Gravity Brake Castors



To compensate the low height on low beds by spreading the weight and making the bed easy to manoeuvre.

# Options and Accessories for Profiling Beds

## Handset Options

There is a range of Dewert handsets for use on the range. Every bed comes with an 8-function handset as standard. Alternatively, a 9 or 10-function handset can be purchased to provide Trendelenburg and anti-Trendelenburg positioning respectively.

### 8-Function Handset



Offers back elevation, knee brake and lower leg elevation.

#### Ordering Details

**Comes as standard**

### 8-Function Swipe Handset



8 functions with magnetic swipe key to activate.

#### Ordering Details

New Code	Description
19715 BE	8-Function swipe handset

### 9-Function Handset



9 functions including anti-Trendelenburg positioning and magnetic swipe key activation.

#### Ordering Details

New Code	Description
19699 BE	9-Function handset

### 10-Function Handset



10 functions including Trendelenburg and anti-Trendelenburg positioning. Also features magnetic swipe key activation.

#### Ordering Details

New Code	Description
19721 BE	10-Function handset



# Options and Accessories for Profiling Beds

## Trendelenburg Kit

A Trendelenburg kit automatically redefines a standard profiling bed into a hospital bed.  
A medical professional must prescribe this option.

### The Trendelenburg kit when used in combination with CasaBeds is:

- Compliant with IEC 60601-2-52, which specifies the inclusion of an emergency lower for CPR
- Operable if power failure occurs, due to the 24V battery back-up pack

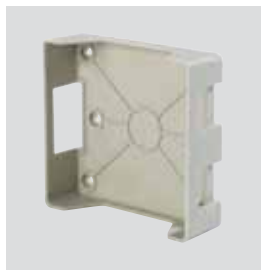

#### Ordering Details

New Code	Description
16207 BE	Steel bracket

#### Ordering Details

New Code	Description
19722 BE	Plastic cover

#### Ordering Details

New Code	Description
19723 BE	24V Battery pack

#### Ordering Details

New Code	Description
71846 BE	Control box charger

#### Ordering Details

New Code	Description
19721 BE	10-function handset

# Options and Accessories for Profiling Beds

## Safe Use of Bed Rails

While bed rails prevent many falls, if fitted incorrectly they can cause death by asphyxiation through entrapment. A risk assessment that incorporates the bed occupant, proposed equipment, the bed and the mattress is essential to ensure safe use. If any of these circumstances change, the risk assessment must be carried out again.

Medicines and Healthcare products Regulatory Agency (MHRA) investigations have also shown that many serious and fatal incidents with bed rails have been caused by lack of maintenance. Bed rails must be inspected on a regular basis to ensure they are in good condition.

As illustrated in the diagram below, the following are key dimensional requirements for use with adults:

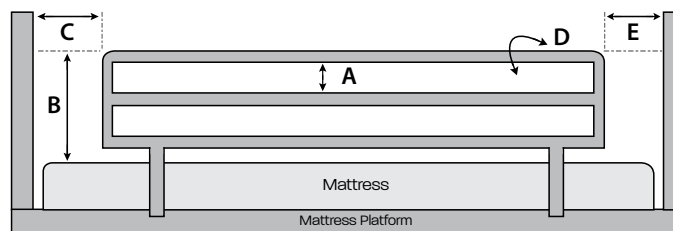

### Key

- A** All gaps between the rail bars must be 120mm or less
- B** The height of the top of the side rail above the uncompressed mattress and with the bed board in a flat position must be equal to or greater than 220mm
- C** The gap between the bed rail end and headboard must be less than 60mm
- D** The deflection of rail should not be greater than 50mm during application of the loads and not greater than 10mm at any point in relation to the bed board after the removal of the loads
- E** The gap between the footboard and rail should be greater than 318mm

## Rails for Profiling Beds

### Folding Bed Rails



#### Features & Benefits

- Standard or Extra high
- Rail folds down flat for ease of side transfer
- One piece rail and clamp
- Easy to clean powder coated steel tube
- Fully compliant to BS standards
- To ensure the rail is correctly fitted, all Casa Med low beds without integral rails are fitted with a rail fitting safety label
- Overall length of rail – 144cm (56½")
- Overall height from base section – **3 bar:** 37cm (14½")/**4 bar:** 49.1cm (19¼")
- If cot bumpers are required for above rails, please order:

**CSB9SL BE** – Standard  
**CSBLEH BE** – Extra High

**For maintenance tips see page 47**

#### Ordering Details

Product Code	Description
9SL BE	Standard folding bed rail (3 bar)
9SLEH BE	Extra high folding bed rail (4 bar)

## Extension Rails

### With Extra High Integral Side Rails



#### Features & Benefits

- Helps ensure the rail is kept within BS height requirements when the total mattress thickness exceeds the recommended height for rail fitting
- Rail simply sits on the top rail and is secured with two hand knobs
- ¾ Length and full length sizes available
- Supplied in pairs
- Fully compliant to BS standards
- Increases height of integral rails by 18.5cm (7¼")  
Overall height from base section 56cm
- If cot bumpers are required for above rails, please order:

**874M BE** – Standard  
**874MH BE** – Extra High

#### Ordering Details

Product Code	Description
H1005 BE	¾ Length extra high side rails
H1006 BE	Full length extra high side rails

# Bed Rails and Clamps

## For Divan Beds



### Features & Benefits

- Available in standard or extra high for use when the total mattress thickness exceeds the recommended height for rail fitting
- Fully compliant with BS safety standards
- Adjustable cross-braces to fit single, double and three quarter sized beds
- Length of the rail can be adjusted to suit various sized beds
- Robust chrome plated steel
- Spring loaded buttons on the clamps for ease of fitting
- Once fitted, rails are very secure

### Technical Specifications

- Width Adjustment 91.5-157.5cm (36-60")
- Length Adjustment 122-193cm (48-76")
- Gap Between Rails 10.2cm (4")
- Maximum Height from Base Section:  
43cm (17") – Standard  
54.5cm (21½") – Extra High

## For Box Section Beds



### Features & Benefits

- Clamps fit directly on to box section bed frames

#### Ordering Details

Product Code	Description
8 BE	Standard home bed rails for divan bed
8EG BE	Extra high home bed rails for divan bed

#### Ordering Details

Product Code	Description
8L BE	Bed rails for box section beds (standard)
8EGL BE	Bed rails for box section beds (extra high)

## Cot Bumpers

For Profiling Beds



### Features & Benefits

- Easy to clean and wipe down
- Quick and easy to fit, secured with hook and loop
- Provides a safe caring environment
- Reduces the risk of entrapment
- Fits 3 bar & 4 bar rails

### Technical Specifications

- Size **130cm (51¼") Length** (875 BE)
- **183cm (72") Length** (876 BE)

#### Ordering Details

Product Code	Description
875 BE	Cot bumper (130cm length)
876 BE	Cot bumper (183cm length)

## Cot Bumpers with Mesh

For Standard Height Profiling Beds with Integral Side Rails



### Features & Benefits

- Ensures two-bar wooden rails are totally enclosed, for a safe and friendly environment
- Covered in FR cream, PVC inner CM foam and hook and loop to close

### Technical Specifications

- Size **200×76cm (79"×30")** (874M BE)
- **203×74cm (80"×29")** (874MH BE)
- Head bumper also available



#### Ordering Details

Product Code	Description
874M BE	Standard cot bumpers with mesh
874MH BE	Extra high cot bumpers with mesh
HFSTD BE	Headboard/Footboard cot bumper



# Accessories for Profiling Beds

## Bed Extension Kit - Standard

### Bed Extension Kit



#### Features & Benefits

- Enables a profiling bed to be extended by 22cm/9"
- Fits users from 196 to 216cm/6'5" to 7'1"
- The Extension Bracket fits to the foot section while the Mattress Infill and Longer Side Rails ensure a safe caring environment

### Mattress Infill



#### Technical Specifications

- Extension 22cm (8½")

#### Ordering Details

Product Code	Description
21804 BE	Standard bed extension (90cm wide)
CX66 BE	Mattress infill (15cm depth x 90cm wide)
10485 BE	Longer wooden side rails (220cm)

### Longer Side Rails



- Longer wooden side rails to accommodate bed extension

## Bed Extension Kit - Bariatric

### Bed Extension Kit



#### Features & Benefits

- Enables a profiling bed to be extended by 22cm/9"
- Fits users from 196 to 216cm/6'5" to 7'1"
- The Extension Bracket fits to the foot section while the Mattress Infill and Longer Side Rails ensure a safe caring environment

### Mattress Infill



#### Technical Specifications

- Extension 22cm (8½")

#### Ordering Details

Product Code	Description
21804B BE	Bariatric bed extension (120cm wide)
FFC66B160 BE	Bariatric mattress infill (16cm depth x 120cm wide)
25310 BE	Telescopic integral metal side rails

### Longer Side Rails



- Longer metal side rails to accommodate bed extension

# Patient Pole

with Triangle



## Features & Benefits

- Offers additional positioning for lying or sitting in bed
- Can be fitted to the left or right side of all Casa Med profiling beds
- Adjustable height strap
- Moulded plastic handgrip

## Technical Specifications

- Height **191cm (75")**
- Handle Adjustment From Floor **95-131cm (37½-51½")**
- Overall Width **80cm (31½")**
- Overall Depth **61cm (24")**
- Height of Base Section **4cm (1¼")**

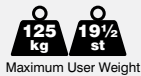

Maximum User Weight

### Ordering Details

Product Code	Description
21873 BE	Patient pole with triangle

# Bed Loop



## Features & Benefits

- Offers additional support when getting into and out of bed
- Can be used alongside other aids to provide additional positioning support
- Easily secured using two hand knobs
- Made from powder coated steel

## Technical Specifications

- Length **48cm (18¾")**
- Width **15cm (6")**
- Height from top of mattress support (9CGR BE) **38cm (15")**
- Height from top of mattress support (9CGRL BE) **60cm (23½")**
- Gap at widest point **9.8cm (3¾")**



Maximum User Weight

### Ordering Details

Product Code	Description
9CGR BE	Bed loop (38cm)
9CGRL BE	Bed loop (60cm)

# Co-ordinating Accessories

## Bedside cabinets

To compliment our range of Casa Med Home Nursing Beds, we offer bedside cabinets. All of which are available in the same beech wood effect finish.

### Features & Benefits

- Attractive Beech MDF wood-effect bedside cabinet with ABS-protected edges
- The top drawer is lockable (R4 only) with chrome-effect fittings
- Castors allow easy positioning and are supplied with two brake versions
- Cabinets' colour match our CasaBed range offering a great combination for the bedroom
- Cabinet is supplied ready assembled but the fittings require self-assembly

### Technical Specifications

- Size (W×D×H)
  - R4: 42.5×45×86.5cm  
(16¾"×17¾"×34")
  - R3: 53×45×86.5cm  
(20¾"×17¾"×34")
- Weight
  - R4: 26kg
  - R3: 40kg
- Material
  - MDF Beech Effect Wood

### Ordering Details

Product Code	Description
R3 BE	Bedside cabinet with tilt adj. overbed table
R4 BE	Bedside cabinet



R3: With Tilt-Adjustable Overbed Table



R4: Without Tilt-Adjustable Overbed Table

# The Importance of Mattress Selection

Selecting the most appropriate mattress for each user's needs is crucial to ensuring correct pressure care and management. When selecting a mattress the user's skin should be assessed to determine the risk he or she is at from developing a pressure ulcer. This assessment can also identify the beginning of pressure damage.

The Casaflex range of mattresses are designed with performance and affordability in mind. They offer highly affordable pressure care solutions for those ranging from at risk to at high risk pressure ulcer development.

Our Closure fabric has been developed over a number of years to withstand up to fifty times the normal level of contact with chlorine based cleaners (usually specified as 1,000ppm) which can mean a dramatic reduction in the amount of replacement mattresses needed by a Hospital each year. Closure has been subjected to over 100 washes with and without rinsing, whilst maintaining waterproof and physical characteristics expected from modern mattress fabrics, providing a major breakthrough in the defence against the effects of using high or inappropriate levels of chlorine.

Triflex is the most versatile mattress for use in all healthcare environments. Particularly suitable for Palliative Care & Nursing Homes.

All these mattresses have been specifically designed to be used with our range of Home Nursing Beds. All mattresses are CE marked and have been clinically tested.



**casaflex**<sup>™</sup>  
By *drive*

**CL<sup>o</sup>sure**  
ULTIMATE COVER PROTECTION

**TRI-FLEX**<sup>™</sup>  
shaping for comfort

## Remember:

When selecting a mattress for a bed with side rails, the distance between the top of the side rail to the top of the mattress without compression should be equal or greater than 220mm.

# Introducing Casa Mattresses

CasaSolo and CasaFlex mattresses are designed with performance and affordability in mind. They offer highly affordable pressure care solutions for those ranging from at risk to at high risk of pressure ulcer development.

Every Casa mattress features:

- Combustion modified high resilient (CMHR) foam for durability, comfort and great pressure redistribution
- High weight capacity to suit a wide range of users
- Fire retardant to BS7177:2008 Medium Hazard (Crib 5 Composite)
- Sewn, vapour permeable and waterproof cover for breathability and hygiene
- Two-way stretch cover to reduce shear and friction forces



Product Code	CS5-SP BE	CS5 BE	CX63 BE	CX64 BE
<b>Max. User Weight</b>	140kg	140kg	213kg	171kg
<b>4 Way Turn</b>	•	•	•	
<b>No Turn</b>				•
<b>Risk Level</b>	Comfort	Medium	High	High
<b>Waterlow Score</b>	n/a	10	15	20
<b>Warranty</b>	1 Year	1 Year	2 Years	2 Years
<b>Foam</b>				
<b>Foam Type</b>	Single Foam	Single Foam, Castellated Cut	Single Foam, Profiled on both sides	Basic Foam with Visco Elastic Foam Top
<b>Thickness</b>	12.7cm	13cm	15cm	15cm
<b>Size</b>	199×90cm	199×90cm	199×90cm	199×90cm
<b>Cover</b>				
<b>Seam</b>	Sewn 2-way stretch	Sewn 2-way stretch	Welded	Sewn 2-way stretch
<b>Fire Retardancy</b>	BS 7177:2008 Medium Hazard	BS 7177:2008 Medium Hazard	BS 7177:2008 Medium Hazard	BS 7177:2008 Medium Hazard
<b>Vapour Permeable</b>	•	•	•	•
<b>Waterproof</b>	•	•	•	•
<b>Weight</b>	10kg	10kg	10.7kg	16kg

# Introducing Prima & Closure Mattress Covers

Closure mattress covers are PU coated, multi-stretch, vapour permeable and waterproof knitted nylon. High frequency welded seams and double-sided flaps protect the zip closures.

Wipe clean covers are impregnated with an anti-microbial agent in the fabric coating, which are resistant to bacterial growth, including MRSA, fungal growth and house dust mite. Light coloured substrate fabric to help identify interior staining.

Using Closure covers reduces cleaning time and increases cover longevity.

Clinically tested surface providing excellent pressure distribution and patient comfort. Suitable for profiling and non-profiling bed bases.



**Prima Multi Zone**

**Prima Plus**

Product Code	FFC6 BE	FFC6C BE
<b>Max. User Weight</b>	257.1kg	280.2kg
<b>Risk Level</b>	High	High
<b>Waterlow Score</b>	•	•
<b>Warranty</b>	2 Years reducing***	4 Years reducing***
<b>Foam</b>		
<b>Foam Type</b>	Profiled CMHR foam construction	Profiled CMHR foam surface with firm edges and supportive base. Unique machine-hinged profile design
<b>Thickness</b>	15cm	15cm
<b>Size</b>	199x90cm	199x90cm
<b>Cover</b>		
<b>Seam</b>	Welded	Welded
<b>Fire Retardency</b>	BS 7177:2008 Medium Hazard	BS 7177:2008 Medium Hazard
<b>Vapour Permeable</b>	•	•
<b>Waterproof</b>	•	•
<b>Weight</b>	12kg	14kg

# TRI-FLEX Mattress



TRI-FLEX is the most versatile mattress for use in all healthcare environments and is particularly suitable for palliative care and nursing homes.

## Features & Benefits

Excellent clinical outcomes particularly for heels. Case studies show that the healing process of existing sores can be accelerated. There are potential cost savings in nursing time and reduced investment in other equipment. The finest quality high resilient foams used to provide excellent pressure distribution and improve patient comfort. TRI-FLEX provides the resident with a comfortable, static and noiseless mattress which enables them to get a good night's sleep, whilst relieving pressure from all areas of the body.

TRI-FLEX system components can elevate the heels completely (as recommended by the EPUAP-NAUAP Guidelines 2009). These guidelines give advice and recommend devices for the management of heel pressure ulcers: "Ensure that the heels are free of the surface of the bed" and section 3.2 notes that, "Heel protection devices should elevate the heel completely (offload them) in such a way as to distribute the weight of the leg along the calf without putting pressure on the Achilles tendon..." The ingenious design allows for complete freedom in positioning. Interface pressures can be minimised in areas requiring protection by adjusting the shape of the mattress surface to take into consideration: height, weight and additional health factors, such as oedema, pressure sores or other ulcerations.



### Mattress cover specification

PU coated, multi-stretch, vapour permeable, waterproof knitted nylon. Sewn seams and double sided flap to protect zip closure with non-slip base. Wipe clean cover, impregnated with antimicrobial agent in the fabric coating. Resistant to bacterial growth, including MRSA, fungal growth and house dust mite. White substrate fabric to help identify interior staining.

#### Specification - standard size

1930×910×150mm (alternative sizes available. POA)

#### Weight

15kg

#### Warranty

4 years

Layered foams complies with BS177:2008 medium

SB54/120/SB41/130/SB36/140/SB40/170

### Top 2 layers folded back



### Wedge inserted



### Middle layer rolled



### Ordering Details

#### Product Code

TRI/PBE	Tri Flex Mattress
TRI/SWBE	Small Wedge
TRI/LWBE	Large Wedge

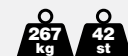

Maximum User Weight



# Wide Heavy Duty Bariatric Mattress

Our 120cm wide heavy duty bariatric mattresses have been designed for use with our Casa Med Bariatric Beds.



Product Code	DH6BUK120 BE	FFCB BE	FFCB160 BE
<b>Max. User Weight</b>	394kg	294kg	294kg
<b>Risk Level</b>	High	High	High
<b>Waterlow Score</b>	20	20	20
<b>Warranty</b>	4 Years reducing***	4 Years reducing***	4 Years reducing***
<b>Foam</b>			
<b>Foam Type</b>	3 Layer Construction	2 Layer Construction	2 Layer Construction
<b>Thickness</b>	17.8cm	17.8cm	16cm
<b>Size</b>	200×120cm	200×120cm	200×120cm
<b>Cover</b>			
<b>Cover</b>	•	Closure fabric protection to 50,000ppm chlorine	Closure fabric protection to 50,000ppm chlorine
<b>Seam</b>	Sewn	Welded	Welded
<b>Fire Retardency</b>	BS 7177:2008 Medium Hazard	BS 7177:2008 Medium Hazard	BS 7177:2008 Medium Hazard
<b>Vapour Permeable</b>	•	•	•
<b>Waterproof</b>	•	•	•
<b>Weight</b>	20kg	20kg	20kg
	Suitable for use with the following beds:- 21990B BE & 21991B BE	Suitable for use with the following beds:- 21990B BE & 21991B BE	Suitable for use with the following beds:- 21990B BE, 21991B BE, 21990BUltra BE & 21991BUltraBE

# Introducing Safety Floor Mattresses



## CasaFlex Safety Floor Mats

The CasaFlex safety floor mats have been designed to provide added security in combination with the CasaBeds. There are two versions available: one flat and one space conserving folding mat.

These safety mats are commonly used with our low beds with a height range commencing 230mm.

The safety mat itself has a height of 76mm. If our low beds are used in conjunction with our CasaFlex mattress CS5 (130mm high), the distance between the top of the mattress to the top of the safety mat without compression is 284mm.

### Ordering Details

Product Code	Description
CX35 BE	Safety Mat
CX35F BE	Folding Safety Mat

# Mattress Accessories

The FFCUL BE Underlay is for use with Dynamic Systems or the Casaflex range of mattresses.



Image of FFCUL BE is shown under a standard mattress

<b>Product Code</b>	<b>FFCUL BE</b>
<b>Max. User Weight</b>	140kg
<b>4 Way Turn</b>	•
<b>Risk Level</b>	At Risk
<b>Waterlow Score</b>	n/a
<b>Warranty</b>	1 Year
<b>Foam</b>	
<b>Foam Type</b>	Single Foam
<b>Thickness</b>	5cm
<b>Size</b>	193x91cm
<b>Cover</b>	
<b>Seam</b>	Sewn
<b>Fire Retardency</b>	BS 7177:2008 Medium Hazard
<b>Vapour Permeable</b>	•
<b>Waterproof</b>	•
<b>Weight</b>	8kg

#### Ordering Details

Product Code	Description
FFCUL BE	Underlay

# Installation

## For Profiling Beds

All CasaBeds are easy to put together by one person.

To help you, key features include:



### Tool-Free

Tool-free assembly and disassembly.



### Pre-Installed Motors

Only two motors to install and quick release pins on both.



### Clear Diagrams

Clear diagrams on the bed show motor orientation.

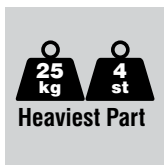

### Safe Lifting Weight

All sections are below the safe and legal maximum lifting weight limit.

When selecting a location for the bed, you need to take into consideration the following space requirements:

### Space Requirements

- There must be enough space to nurse the patient in the bed on at least one side
- There must be an easily reachable mains socket
- The illustration shows you the space you should allocate for nursing around the bed

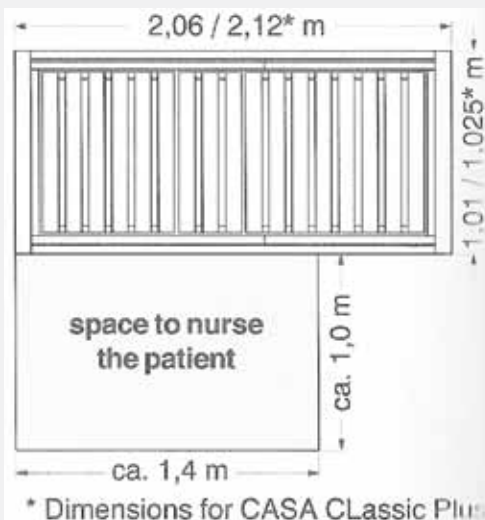

# Maintenance

## For Profiling Beds

Every six months you should inspect the control unit. To do so first lock all adjustment functions at the handset, then carry out the following performance check:

### Performance Check

Test all functions by activating the relevant function keys on the handset. None of the adjustment functions should react. If a function starts operating, the control unit must be replaced.

For more maintenance tips, please refer to the operating manual.

# Cleaning

## For Profiling Beds

When cleaning CasaBeds remember to:

### Cleaning

- Use a soft damp cloth and avoid sharp-edged tools such as knives
- Use mild cleansers free of scouring agents for cleaning metal, wooden and plastic surfaces

# Safety and Maintenance For Bed Rails

## Safety instructions for underweight users:

- If the user is underweight, ensure they cannot slip down between the mattress and bed rails
- As a precautionary measure, it is advisable to use cot bumper pads and ensure the mattress is the correct width for the bed

Never set the side rail in a diagonal position



9SL and 9SLEH Bed Rails - see page 34



To maintain these rails you should regularly check:

- The hand levers are tightened to secure clamp brackets on the bed frame
- The rail pivot points rotate freely and there is no excess side deflection
- The spring loaded release pin operates correctly
- For structural damage that could impede safe use

# Casalift Mobile Hoist

## Features & Benefits

- The new Casalift 18001 electric hoist features a compact design that incorporates a wide leg width adjustment
- The lightweight frame is easy to move into position, and allows the user to achieve a lower lifting position from the floor
- All components are interchangeable
- Compact for easy access through domestic doorways
- High lifting range and safe working load for greater versatility and maximum flexibility
- Ergonomic, user-friendly handset features patient-lifting symbols for easy identification, as well as recessed buttons to reduce the chance of unintended operation if the handset is dropped. It also has a magnetic back, making it easy to position on to the hoist
- Actuator features emergency lowering function, which is easier to control than a traditional quick-release actuator and harder to misuse
- Exchangeable cable which allows for cable damage to be rectified by replacing just the cable, rather than the whole actuator
- Control box features emergency stop and descent functions, as well as an acoustic low battery alarm which emits an alert at 50% battery level
- Easy to service, maintain and clean

## Technical Specifications

- |                          |                                     |
|--------------------------|-------------------------------------|
| • Lifting Capacity       | 180kg                               |
| • Total Weight           | 35kg                                |
| • No. Lifts per Charge   | +/- 40 lifts at 85kg                |
| • Charging Time          | 5 - 14 hours                        |
| • Front Castor Diameter  | 75mm                                |
| • Rear Castor Diameter   | 100mm                               |
| • Chassis                | 4 Lightweight Castors               |
|                          | 360° Swivelling Braked Rear Castors |
| • Colour                 | Silver                              |
| • Chassis Width (Open)   | 116cm                               |
| • Chassis Width (Closed) | 59cm                                |
| • Chassis Length         | 115cm                               |
| • Boom Height at Lowest  | 47cm                                |
| • Boom Height at Highest | 183cm                               |
| • Boom Length            | 75cm                                |



## Ordering Details

Product Code	Description
18001 BE	Casalift 18001 Hoist



# Mobile Hoist Feature Explanation

## Angled Boom



Helps to lift the person up from the floor as it positions the spreader bar nearer to the floor, while allowing plenty of head room for the person in the sling.

## Battery Location



The batteries are located at a convenient height on the mast, so the carer does not have to stoop.

## Battery Charging



The battery pack is detachable for ease of charging.

## Battery Level Indicator



This important LCD visual indicator will ensure you know how much charge is remaining.

## Castor Diameter



Small front castors enable the hoist to go underneath furniture, while larger back castors make the hoist easier to push.

## Chassis Height



This will determine whether the hoist can go under certain items of furniture.

## Chassis Length



A longer chassis will take up more floor space and will be more difficult to manoeuvre. However, it will give a tall person more leg room and provide greater stability when executing high lifts.

## Chassis Shape



The chassis of all our hoists is C-shaped to allow the boom and spreader bar to be brought in from one side. This can reduce the feeling that the spreader bar will touch the face of the person in the sling. It also enables the user to be transferred from a chair into an adjacent bed without turning them or the hoist.

## Chassis Width



It is useful to adjust the width of the chassis to avoid obstacles or go through narrow doorways.

## Emergency Cut Out



This will stop the lowering mechanism if the spreader bar meets any resistance, such as on object or person.

## Emergency Lowering



This enables the person to be lowered if there is a failure in the hand set or electronics.

## Hand Held Controls



These are available on a flex to provide the user with some independence and allow the carer to have both hands free to assist or position the user.

## Parallel Leg Openings



These offer three main benefits: facilitates access in a variety of settings, enables lifting to and from the side of a wheelchair and allows maximum parallel space between the legs, which is particularly advantageous when lifting from the floor.

## Remember:

- Mobile hoists are not designed to transport users over long distances. A ceiling mounted hoist or wheeled equipment, such as a wheelchair, should be used instead.
- Brakes are generally not applied unless the hoist is parked, being assembled, being used on a slope, or if the person's legs are likely to cause the hoist to move unsafely.

**Tip:** To ensure the batteries always have sufficient charge, it is important to have an agreed charging routine, such as when not in use or every night.

## Factors to consider when choosing a hoist sling:

- The amount of support required
- The tasks which need to be undertaken
- The comfort of the person being lifted
- The ability of the person being lifted
- The ability of the carer
- The hoist used



## Remember:

- Loops are for positioning the person correctly in the sling, not for trying to make a sling that is too big or too small fit.
- It may take several positioning attempts before a comfortable position is found. Once found, it is worth marking the loops used to avoid wasting time in the future.

### Divided Leg Slings



#### Advantages

- This type of sling can be easily put on and taken off in most positions
- Provides good access for washing and toileting
- Offers a choice of leg positions
- With the correct size sling and leg bands in the crossed position, it is virtually impossible to fall out
- The user may be able to put the sling on independently
- No user co-operation is required

#### Disadvantages

- Leg pieces may be uncomfortable
- Clothes need to be removed for toileting before hoisting
- If the user goes into extensor spasm, he/she may slide out if both leg bands are under both legs

### Toileting Slings



#### Advantages

- Provides good access for toileting and washing
- Easy to put on and take off
- Users may be able to put the sling on independently

#### Disadvantages

- Those with little or no muscle tone may slip through the sling
- Some degree of sitting balance is essential
- User co-operation is required to prevent slipping through the sling
- Only suitable for use from a sitting position

### Hammock Slings



#### Advantages

- Provides full body support
- Safe for most users
- Comfortable for many users because body weight is spread over a large area and pressure areas are unlikely to develop
- No user co-operation is required

#### Disadvantages

- User usually needs to be rolled onto the sling to put on and take off
- The user is not able to put the sling on independently
- Offers little or no access for toileting or washing
- When a commode aperture is present, it may be difficult to line it up accurately
- If the user is being transferred he or she may have to remain sitting on the sling for ease of positioning
- Clothes must be removed for bathing

# Slings

With more than 200 variations, our extensive range of slings ensures regardless of the user's needs, preferences or circumstances, you can find the perfect solution. Each sling is available from extra small to extra large, in polyester or parachute material\*, and can be part or fully lined with one of the four linings available.

Each sling has colour coded loops so you can easily assess its application, and colour coded edges so you can easily determine its size. All slings have a maximum user capacity of 180kg/28st.

Full or part lining in:	Additional Size Options
<ul style="list-style-type: none"> <li>• Simulated Sheepskin</li> <li>• Terry Towelling</li> <li>• Comfort Polyester</li> <li>• Parachute</li> </ul>	<ul style="list-style-type: none"> <li>• Extra small</li> <li>• Extra large</li> </ul>

## Fast Fit Slings

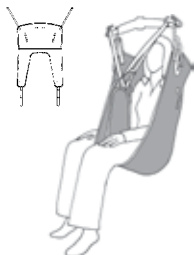

### Features & Benefits

The Fast Fit Sling is an all purpose sling, easy to use with full back and leg support. It has quilted leg pieces for additional support and positional loops to offer different seating positions.

#### Ordering Details

New Code	Description	Size
3201 BE	Fast fit sling - polyester	Small
3202 BE	Fast fit sling - polyester	Medium
3203 BE	Fast fit sling - polyester	Large

## Fast Fit Deluxe Sling



### Features & Benefits

The Fast Fit Deluxe Sling is designed to give full body support, offering additional support to the sacral and thigh area. It has quilted material for extra comfort and positional loops to offer different seating positions.

#### Ordering Details

New Code	Description	Size
3401 BE	Fast fit deluxe sling - polyester	Small
3402 BE	Fast fit deluxe sling - polyester	Medium
3403 BE	Fast fit deluxe sling - polyester	Large
3404 BE	Fast fit deluxe sling - net	Small
3405 BE	Fast fit deluxe sling - net	Medium
3406 BE	Fast fit deluxe sling - net	Large

## Dress Sling



### Features & Benefits

The Dress Sling is an easy to fit general purpose sling, specifically designed for easy access for toileting. The sling allows access to adjust clothing and is fitted with hook and loop waist support for extra security.

#### Ordering Details

New Code	Description	Size
3101 BE	Dress sling - polyester	Small
3102 BE	Dress sling - polyester	Medium
3103 BE	Dress sling - polyester	Large

## Comfort Sling



### Features & Benefits

The new Comfort Sling has been designed to give extra support and comfort. It is a general purpose sling that can be used for toileting with an integral head support.

#### Ordering Details

New Code	Description	Size
3301 BE	Comfort sling - polyester	Small
3302 BE	Comfort sling - polyester	Medium
3303 BE	Comfort sling - polyester	Large

## Long Seat Sling

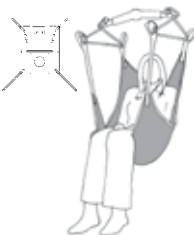

### Features & Benefits

The Long Seat Sling offers additional support to the sacral and thigh area and is supplied with commode aperture.

#### Ordering Details

##### STANDARD SLINGS

New Code	Description	Size
3601 BE	Long seat sling - net	Small
3602 BE	Long seat sling - net	Medium
3603 BE	Long seat sling - net	Large

##### COMMODE SLINGS

New Code	Description	Size
3801 BE	Long seat sling - net	Small
3802 BE	Long seat sling - net	Medium
3803 BE	Long seat sling - net	Large

# Ambiturn Sit-To-Stand Transfer Aid

The Ambiturn Transfer Aid assists with pivoting transfers between different seat surfaces and can transport users short distances.

## Features & Benefits

- Sturdy steel frame provides stable support for user.
- Narrow, recessed front fits between wheelchair wheels and around toilet for perfect positioning.
- Low profile base facilitates user feet placement.
- Substantial base area provides stability, with rear bar also allowing carer to counterbalance.
- Handle has multiple gripping points for varying carer/user support requirements and is angled to enable “nose-over-toe” standing movement.
- Opening on central handle bar allows quick fitting of optional support belts.
- 4 front and rear castors combined with 2 x 13cm (5”) central wheels ensure effortless manoeuvring even with heavier users.
- Foot-operated brakes on centre wheels provide stability during standing/sitting movement.
- Padded lower leg supports can be adjusted (toolfree) in width, angle and height to suit user comfort.
- Easily dismantled/reassembled without tools for transportation and storage.
- Easy wipe-clean surfaces.
- Requires user to pull on handle to stand up and to be weight bearing.

Product Code	PT001
Width	63cm (25")
Height	118cm (46")
Depth	57.5cm (22")
Packaged Width	17cm (6")
Packaged Height	118cm (46")
Packaged Depth	64cm (25")
Weight Capacity	150kg (24st)



**150 kg**  
**24 st**  
Maximum User Weight

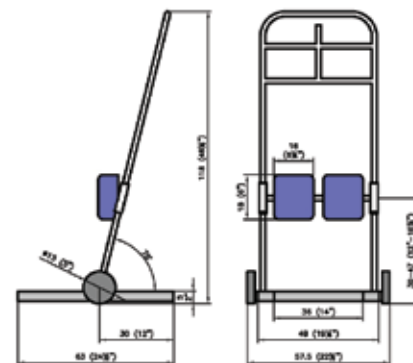

## Ordering Details

Product Code	Description
PT001	Ambiturn Sit to Stand Transfer Aid

# Ablestand Patient Turner

The Ablestand Patient Turner helps a carer or attendant to assist a patient or user to transfer to another seat, bed, wheelchair, toilet or commode by standing and turning.

## Features & Benefits

- Sturdy steel frame provides stable support for user.
- Height adjustable handles to suit user requirements.
- Padded lower leg supports can be adjusted (toolfree) in width, angle and height to suit user comfort.
- Low profile base facilitates user feet placement.
- Substantial base area provides stability, with rear bar also allowing carer to counterbalance.
- Handle has multiple gripping points for varying carer/user support requirements and is angled to enable "nose-over-toe" standing movement.
- Opening on central handle bar allows quick fitting of optional support belts.
- 2 rear castors ensures effortless manoeuvring even with heavier users.
- Easily dismantled/reassembled without tools for transportation and storage.
- Easy wipe-clean surfaces.
- Requires user to pull on handle to stand up and to be weight bearing.

<b>Product Code</b>	<b>PT002</b>
<b>Width</b>	49cm (19")
<b>Height</b>	80-126cm (31"-47")
<b>Depth</b>	45cm (18")
<b>Base Diameter</b>	41cm (16")
<b>Wheel Diameter</b>	8cm (3")
<b>Pad Height</b>	16cm (6")
<b>Pad Width</b>	18cm (7")
<b>Weight Capacity</b>	150kg (24st)



**150 kg** **24 st**  
Maximum User Weight

## Ordering Details

Product Code	Description
PT002	Ablestand Patient Turner

# Solo Toilet Lift

The Mountway Solo Toilet Lift enables users with restricted mobility to get on and off the toilet independently. It has been developed to replicate the natural standing movement at the touch of a button.

## Features & Benefits

- Battery-powered device that enables users with restricted mobility to get on and off toilet at the touch of a button.
- Ideal for individuals who have difficulty performing sit-to-stand activities due to muscle or joint weakness in their legs and/or upper body e.g. due to multiple sclerosis, osteo- or rheumatoid arthritis, hip replacement, heart problems and obesity.
- Helps reduce manual handling risks for carers who provide toileting assistance.
- Powered lifting action replicates body's natural standing movement.
- Seat can be stopped at any position to suit user comfort and support requirements.
- Fits easily and compactly over existing toilet, blending discreetly into modern home.
- Smooth, wipe-clean surfaces for ease of cleaning.
- Acts as a normal toilet seat in lowered position for use by other household members.
- No specialist installation - simply remove existing toilet seat and place over toilet bowl.
- Feet rotate clockwise and anti-clockwise to adjust height for different users/toilets.
- Models also available with tilt-up armrests (with/without integral operating controls), which give additional user support.
- Supplied with two rechargeable batteries to ensure continuous operation.
- Battery level indicator monitors when recharging is required.
- Set of extended feet is available as an accessory to raise seat a further 6.3cm (2.5") for accommodating tall users or high toilets (Product code: TL634).



**160 kg** **25 st**  
Maximum User Weight

## Ordering Details

Product Code	Description
MS2LSUK	Solo toilet aid, left side switch
MS2RSUK	Solo toilet aid, right side switch





## UK Customer Services:

Drive Medical  
North Road, Bridgend Industrial Estate  
Bridgend CF31 3TP

Tel: 01656 664700

Fax: 01656 664727

Email: [info@drivemedical.co.uk](mailto:info@drivemedical.co.uk)

[www.drivemedical.co.uk](http://www.drivemedical.co.uk)

Your Authorised Dealer:

***casa*beds**<sup>TM</sup>  
By *drive*